



GRAND HOTEL EUROPA

HOSPITALITY SOLUTION

ekinex



We were born in 2012, strengthened by our experience in the industrial automation and electronic fields. By enriching this expertise, gained over more than 30 years, with a passion for design, the Ekinex project was born.



# IMPROVING THE QUALITY OF LIFE

Ekinex offers complete solutions aimed at improving people's **quality of life** in an environment that is easy to use and covers a wide range of aspects of living comfort: **thermo-hydrometric, visual, acoustic and air quality comfort.**

Ekinex devices are the result of a combination of **design and technology** to make everyday gestures easier, towards true living comfort.



Ease of use

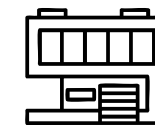

Living comfort



Thermo-hydrometric comfort

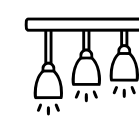

Visual comfort



Acoustic comfort

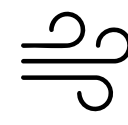

Air quality

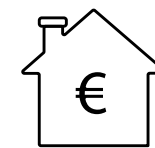

Property value



Saving

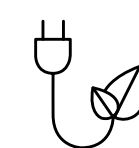

Environmental sustainability



Aesthetic comfort



# BESPOKE SERVICE

We respond to the increasing demand for tailor-made objects with a dedicated service: customised icons that recall the lamps used in the interiors, texts of the customer's choice and a series of special finishes that **make each project unique.**

# WHY KNX

Ekinex devices are based on **KNX, worldwide standard**, open and interoperable, essential to obtain greater energy efficiency in buildings, suitable for both new constructions and renovations.

It is a SELV voltage system which reduces electromagnetic fields in the buildings and it is entirely compliant with national, European and international standards.



# SMART AUTOMATION FOR HOSPITALITY SECTOR

The hospitality industry is evolving rapidly, with increasing demand for seamless guest experiences, operational efficiency and sustainable energy management.

Whether managing a large international hotel chain, a luxury resort, a boutique hotel, or a small B&B, Ekinex offers comprehensive, fully integrated automation solution that grow with your business.

With a centralized platform for managing lighting, climate, shading, audio, access control, and energy efficiency, our solution ensures seamless operation and enhanced guest experiences at any scale.



Canaves Epitome Hotel - Santorini (GR)

# A HIGHLY SCALABLE SOLUTION

The Ekinex hospitality automation system is designed to be highly scalable, adapting to the specific needs of various types of accommodations.

- ▶ **A Single, Scalable Solution** – Whether managing a small boutique hotel or a global hotel chain, Ekinex’s technology adapts to meet your needs.
- ▶ **Seamless Guest Experience** – Personalization and automation for lighting, climate, shading, audio and access control ensure comfort and convenience.
- ▶ **Operational Efficiency** – Remote monitoring, centralized management, improve staff productivity and reduce costs.
- ▶ **Energy Savings & Sustainability** – With Delègo virtual presence function the rooms automatically adjust settings based on occupancy, leading to significant reductions in energy consumption.
- ▶ **Future-Proof & Open Standard** – Based on KNX, the most reliable and interoperable building automation standard, ensuring long-term flexibility and third-party system compatibility.

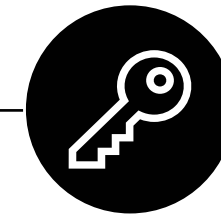

## ACCESS CONTROL

Smart system for secure and authorized access management.

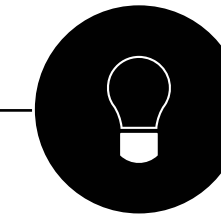

## LIGHTING

On, off, intensity, colours. Make the system flexible to your needs.

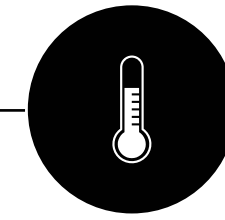

## CLIMATE

Control the temperature and humidity. Adjust your system by time slots.

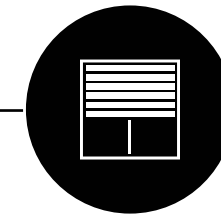

## MOTORISATIONS

Blinds, shutters, venetian blinds. Control the opening and closing of any window.

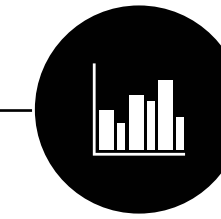

## ENERGY

Check and measure the consumption values of your home.

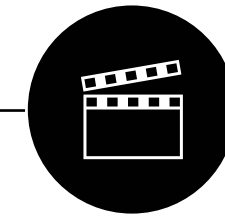

## SCENES

Create combinations of functions that can be recalled with a single gesture.

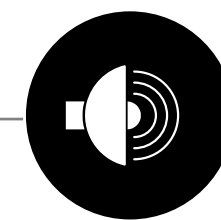

## AUDIO

Listen to your favourite music in any space of your building.

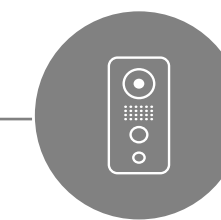

## COMMUNICATION

Visualize and communicate with video door phones on standard SIP protocol.

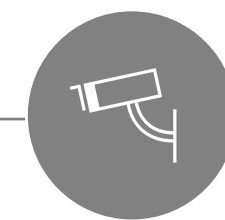

## VIDEO SURVEILLANCE

Displays real-time IP camera footage.

# SCALABLE ACROSS ALL PROPERTY TYPES



## LARGE HOTELS

- ▶ Enterprise-grade automation with full PMS (Property Management System) and BMS (Building Management System) integration.
- ▶ Centralized monitoring of multiple buildings and locations from a single interface. A Desktop Application that connects to all the controllers around the property.
- ▶ Automated guestroom management for personalized comfort and real-time energy savings.
- ▶ Smart access control for staff and guests using RFID, Bluetooth, and NFC keyless entry.



## BOUTIQUE HOTELS

- ▶ Tailored automation for unique properties that require a balance of luxury and technology
- ▶ Premium pushbuttons, thermostats, access control systems, and room controllers not only enhance guest comfort and efficiency but also play a crucial role in the visual and tactile experience of the space
- ▶ Customizable room experiences, from personalized lighting scenes to automated climate adjustments based on occupancy.

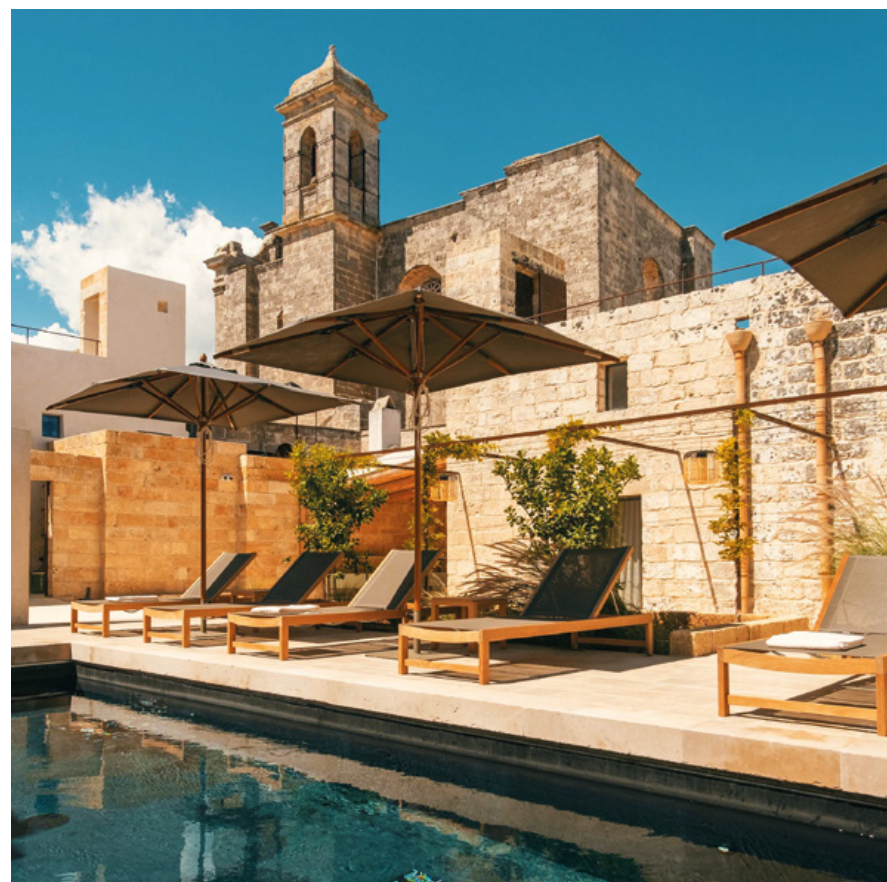

## RESORTS & MULTI-BUILDING PROPERTIES

- ▶ Seamless interconnectivity between multiple facilities (guestrooms, villas, restaurants, spas, and event spaces).
- ▶ Advanced outdoor lighting with DALI protocol for pools, beach areas, and recreational spaces.



## BED & BREAKFASTS (B&BS)

- ▶ Easy-to-install, cost-effective smart solutions for small properties with limited staff.
- ▶ Remote access via mobile app, allowing property owners to manage their facility from anywhere.
- ▶ Automated check-in/check-out processes that improve guest convenience and reduce manual workload.



A P P L I C A T I O N S

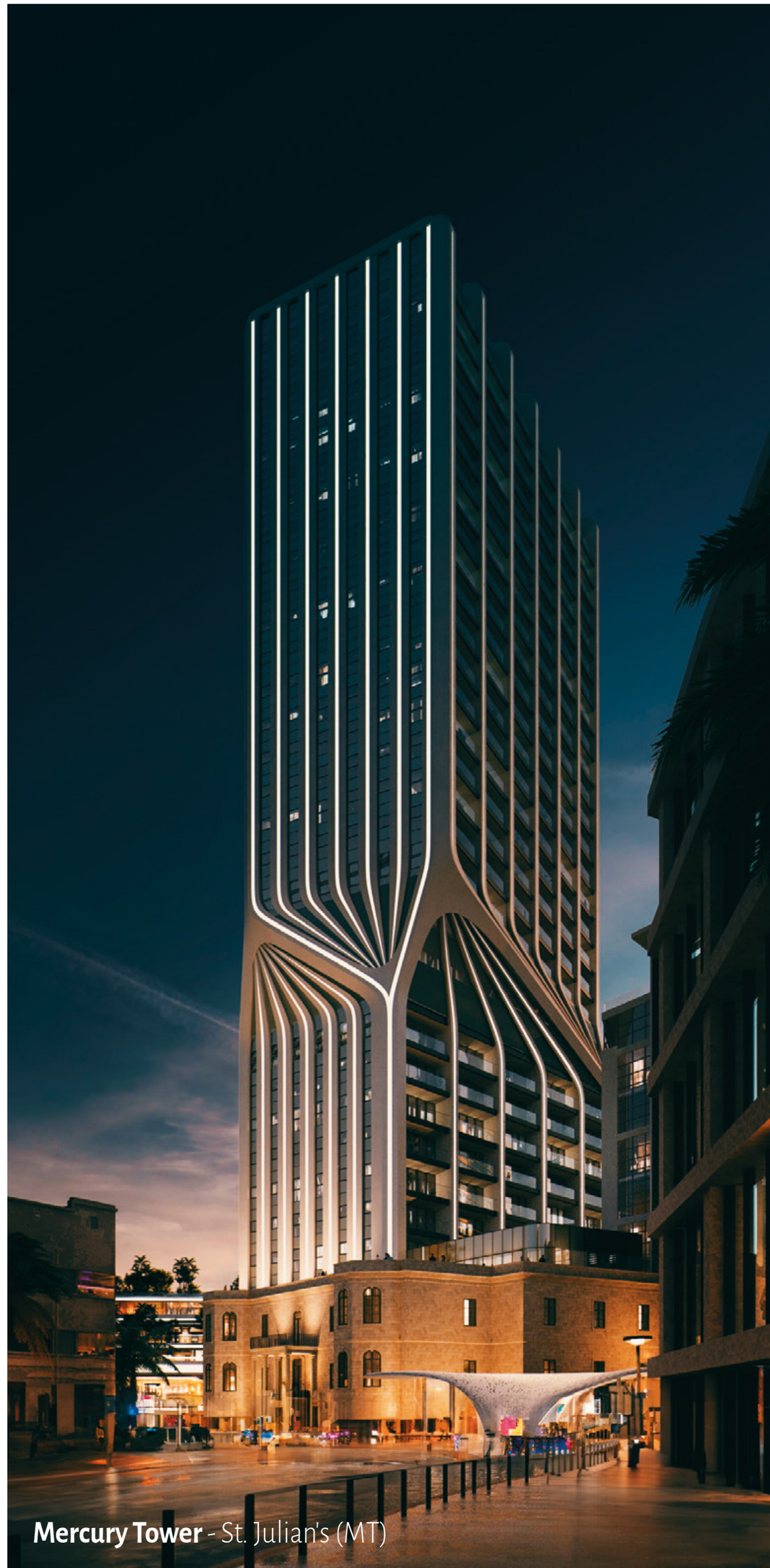

Mercury Tower - St. Julian's (MT)



SERVICED APARTMENTS

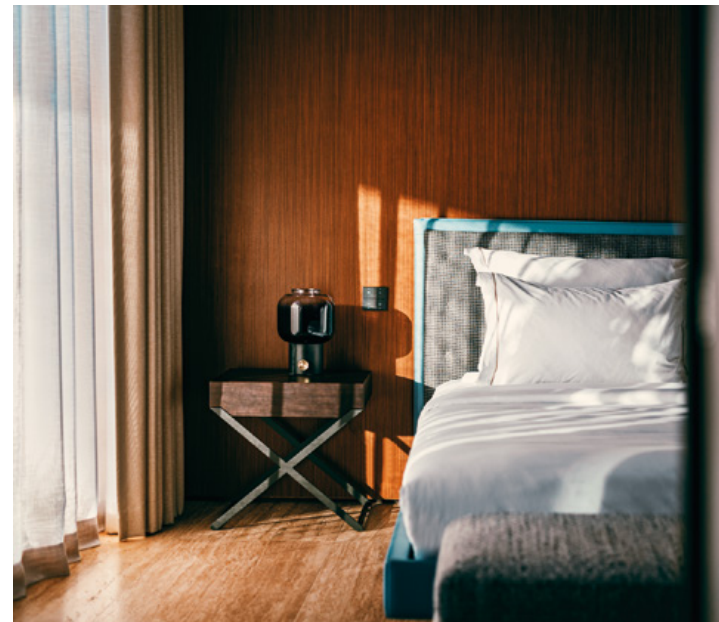

GUESTROOMS



COMMON SPACES

# ONE INTERFACE

Different spaces in a property demand varying levels of control. The Ekinex hospitality solution, powered by KNX and Delégo Suite, seamlessly integrates all areas of a hotel into a single platform. This unified system simplifies property management, enhances guest experiences, and optimizes energy efficiency across all spaces—from guest rooms to public areas and staff facilities.

With Ekinex, hotels can centralize control of lighting, climate, shading, audio and access management, ensuring each space operates at peak performance, efficiency, and comfort.

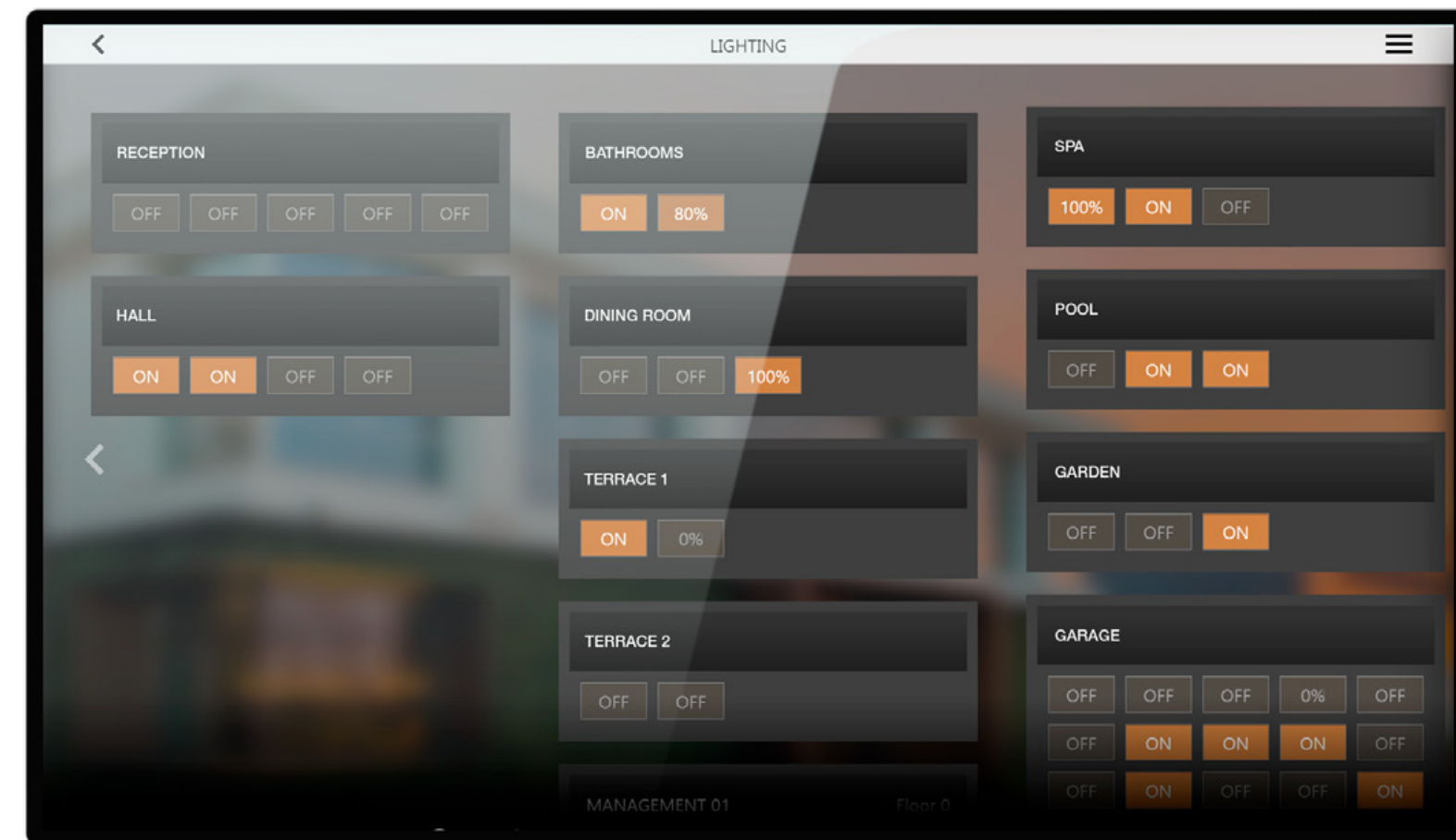

DELÉGO SUITE

# LOBBIES & RECEPTION AREAS

Create a welcoming first impression with adaptive lighting, automated shading, ambient audio, and temperature control that adjusts seamlessly throughout the day.

- ▶ Adaptive lighting adjusts brightness based on time of day using DALI control system.
- ▶ Automated shading to reduce glare while maintaining an inviting atmosphere.
- ▶ Temperature regulation for guest comfort and energy savings.
- ▶ Ambient audio that conveys the desired atmosphere.

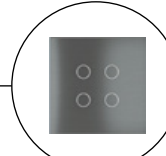

## WALL MOUNTED DEVICES

A design that speaks of beauty and functionality in perfect balance.

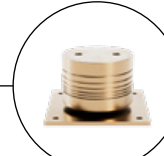

## MULTIROOM AUDIO SYSTEM

Listen to your favourite music in any space of your building.

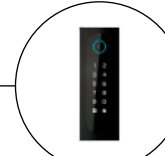

## ACCESS CONTROL

Scalable and adaptable access control system.



Park Hyatt - Milan (IT)



# RESTAURANT & LOUNGES

Enhance the dining experience with scene-based lighting and audio, automated shade control, to create dynamic ambiance settings tailored to different meal services and events.

- ▶ Scene-based lighting and audio control for breakfast, lunch, dinner, and events.
- ▶ Shade automation for natural light optimization while reducing heat gain.
- ▶ Timed presets & mood settings for fine dining, live music, or business lunches.



**DELÉGO  
VISUALISATION**

Thanks to Delégo you stay connected to your home at all times, from anywhere, at any time of day.

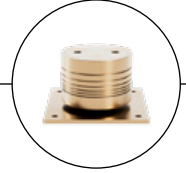

**MULTIROOM  
AUDIO SYSTEM**

Listen to your favourite music in any space of your building.



**SCENES  
CONFIGURATION**

Automated scene presets for every occasion.

# SPAS, GYMS & WELLNESS AREAS

Ensure ultimate relaxation and efficiency with climate and lighting automation that maintains ideal comfort while optimizing energy use.

- ▶ Temperature & ventilation control to maintain an ideal environment.
- ▶ Motion-based lighting that activates when guests enter.
- ▶ Ambient audio that conveys the desired atmosphere.
- ▶ Waterproof protections for spa and pool areas.
- ▶ Integration with BMS to control UTA and other equipment.

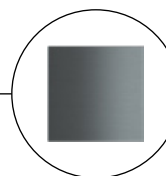

## WATERPROOF PROTECTION

Waterproof protections for spa and pool areas.

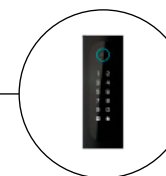

## ACCESS CONTROL

Scalable and adaptable access control system.

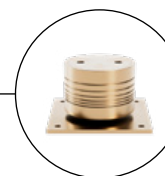

## MULTIROOM AUDIO SYSTEM

Listen to your favourite music in any space of your building.



Pian delle Vigne - Tuscany (IT)



# CONFERENCE & MEETING ROOMS

Seamlessly integrate technology and comfort with, lighting, and shading control for productive and immersive meetings or events.

- ▶ Automation, lighting, and climate control for seamless presentations.
- ▶ Automated scene presets for business meetings, banquets, and corporate events.
- ▶ Booking system integration with API made available by Dèlego Server to optimize room scheduling and energy usage.



## SCENES CONFIGURATION

Automated scene presets for every occasion.

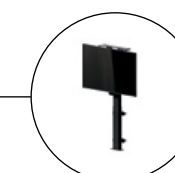

## REVÉLO LIFT TV

Revélo guards the TV and only returns it at your command.

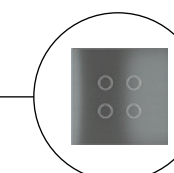

## WALL MOUNTED DEVICES

A design that speaks of beauty and functionality in perfect balance.

# GUESTROOM & SUITES

## PERSONALIZED COMFORT & EFFICIENCY

The guestroom is the core of the hotel experience, where automation should balance comfort, convenience, and energy savings.

- ▶ Automated climate, lighting, and shading based on occupancy and guest preferences.
- ▶ Personalized scene settings (e.g., “Relax Mode,” “Reading Mode,” “Good Night”).
- ▶ Keyless access control (Bluetooth/NFC) for seamless check-in and security.
- ▶ Integration with PMS for automated energy-saving features when the room is unoccupied.
- ▶ Do-not-disturb (DND) & housekeeping indicators linked to the central system.

Example: When a guest checks in, the room automatically adjusts temperature and lighting to a welcoming setting, creating a personalized, luxury experience.

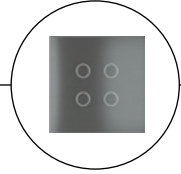

**WALL MOUNTED DEVICES**

A design that speaks of beauty and functionality in perfect balance.



**ACCESS CONTROL**

Scalable and adaptable access control system.



**DELÉGO VISUALISATION**

Thanks to Delégo you stay connected to your home at all times, from anywhere, at any time of day.





# SERVICED RESIDENCES

## INTELLIGENT HOME - LIKE COMFORT

Long-term guests expect personalized control over their environment, similar to a luxury home.

- ▶ Smart home-style automation via Delègo Panels and Delègo mobile app.
- ▶ Customizable temperature and lighting presets for extended stays.
- ▶ Security integration for automated access control and remote monitoring.
- ▶ Voice control integration for an intuitive, hands-free experience.

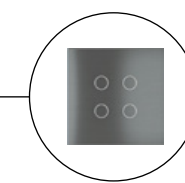

### WALL MOUNTED DEVICES

A design that speaks of beauty and functionality in perfect balance.



### SCENES CONFIGURATION

Automated scene presets for every occasion.

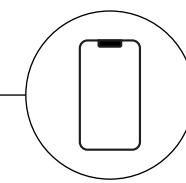

### DELÉGO VISUALISATION

Thanks to Delègo you stay connected to your home at all times, from anywhere, at any time of day.

Grand Apartment - Kyiv (UA)



DE LÉGO S U I T E

# DELÉGO SUITE

## ONE SOFTWARE FOR ALL APPLICATIONS

Ekinex Delégo Suite is an intuitive, centralized software platform that simplifies management and integration. By unifying guestroom automation, access control, energy management, and system integrations, Ekinex provides a smarter, more efficient way to manage hotels of any size.



### DELÉGO DESKTOP

Full-scale control via PC with a web based software, for powerful visualization, data analysis, notifications and reports.

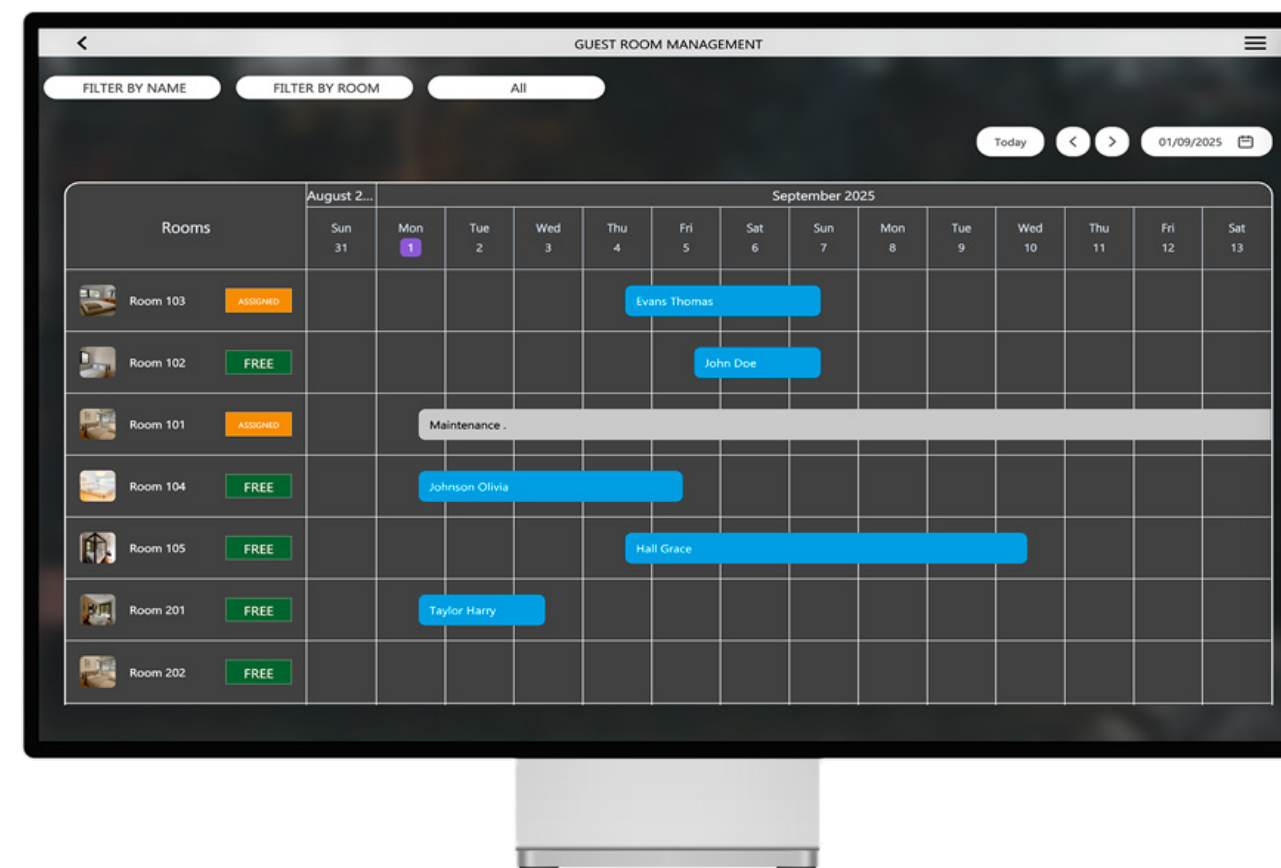

### ACCÉDO MODULE

Guestroom access control management, Bookings administration, easy and fast interface to register guests and create RFID keys. Easy overview of rooms divided by floors and areas.

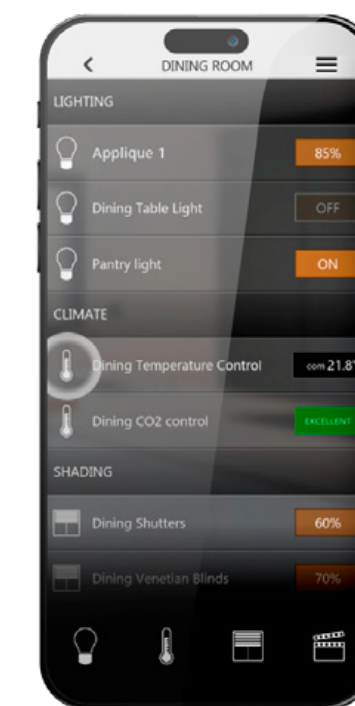

### DELÉGO APP

Mobile and tablet-based app for local and remote access, to control lights, temperatures and scenes of public spaces with an easy and intuitive interface



# BUILDING MANAGEMENT

A well-managed hotel starts with intelligent automation across the entire property.

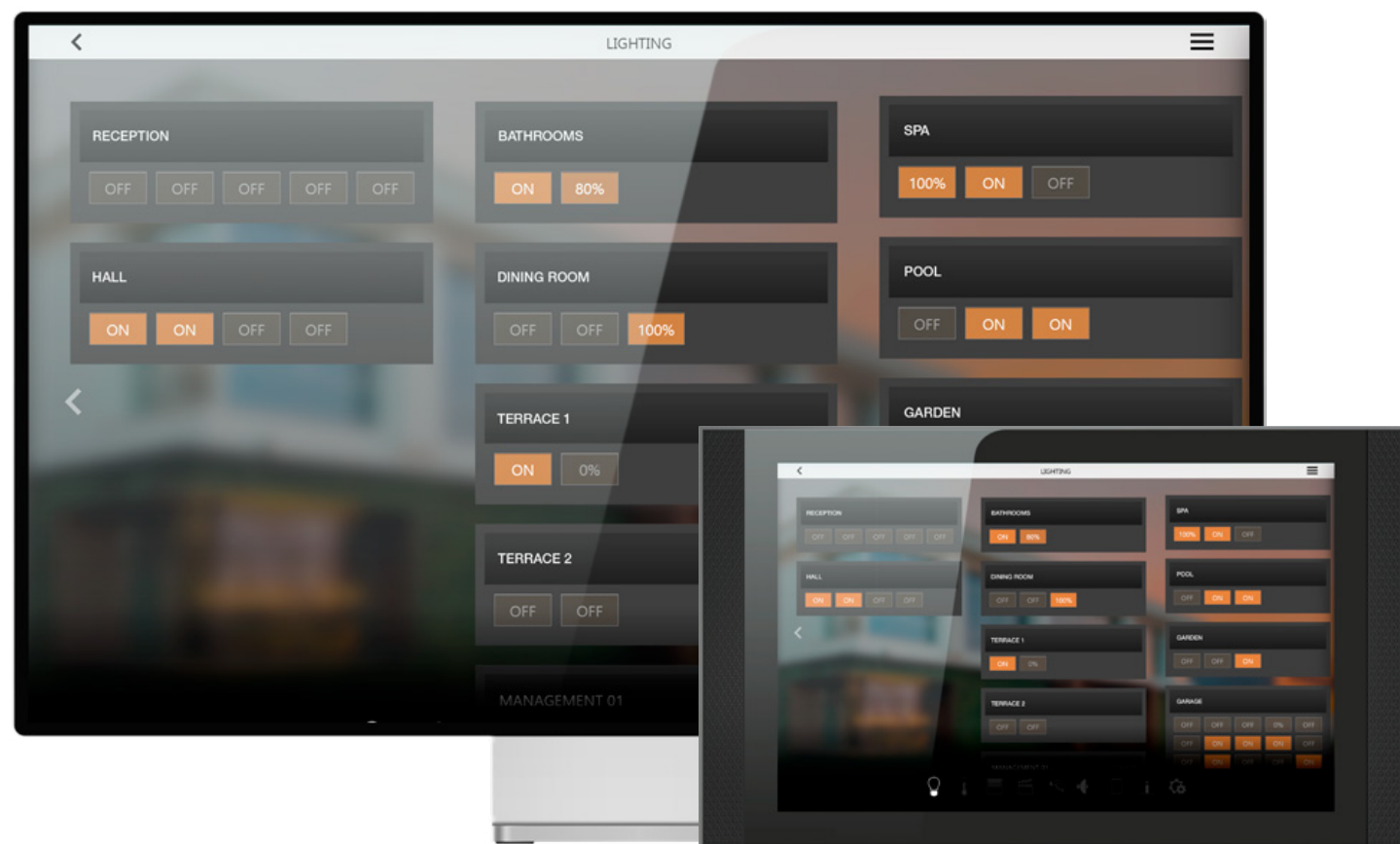

## BUILDING OVERVIEW

KNX-based lighting, climate, and shading control for seamless operation. DALI lighting system integration ensures precise dimming and energy-efficient lighting

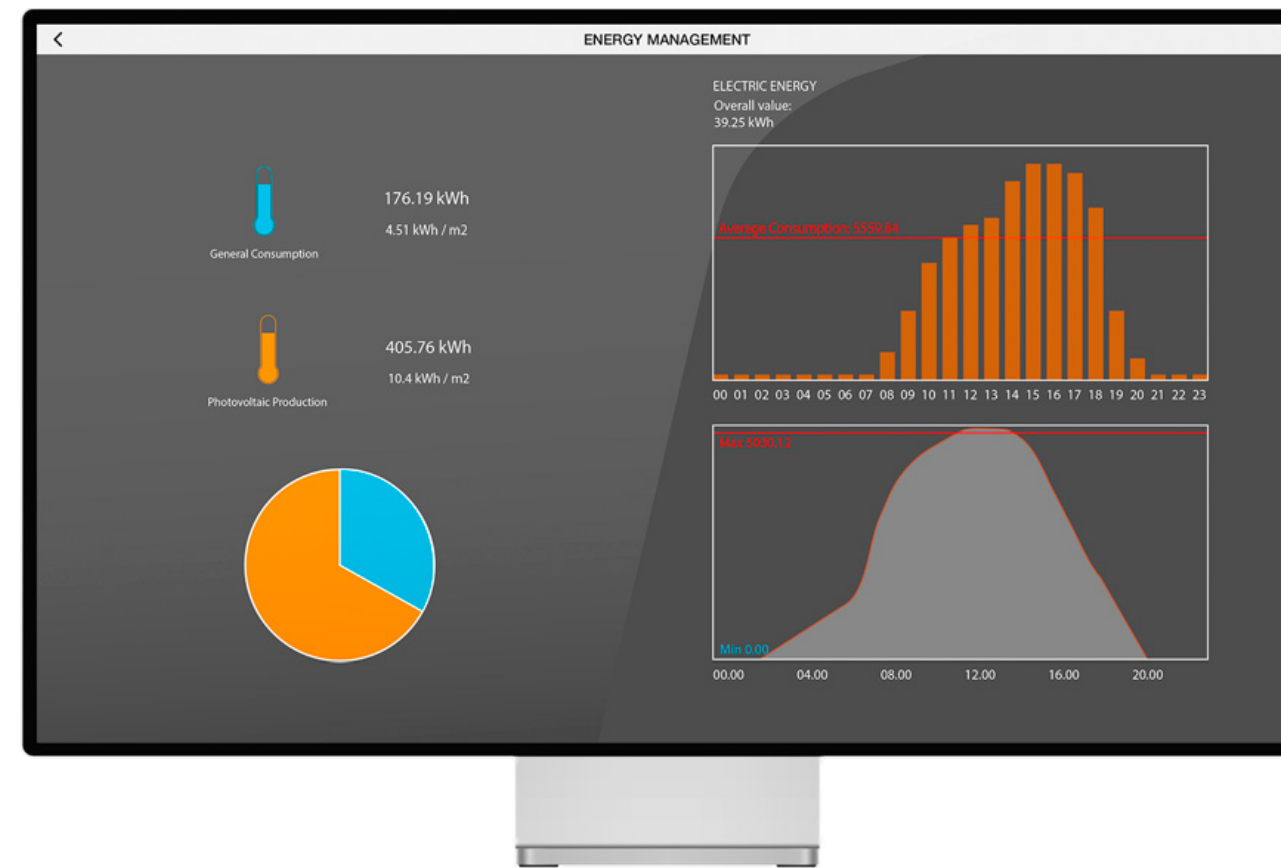

## ENERGY MANAGEMENT

Energy management tools monitor and optimize consumption, reducing operational costs.

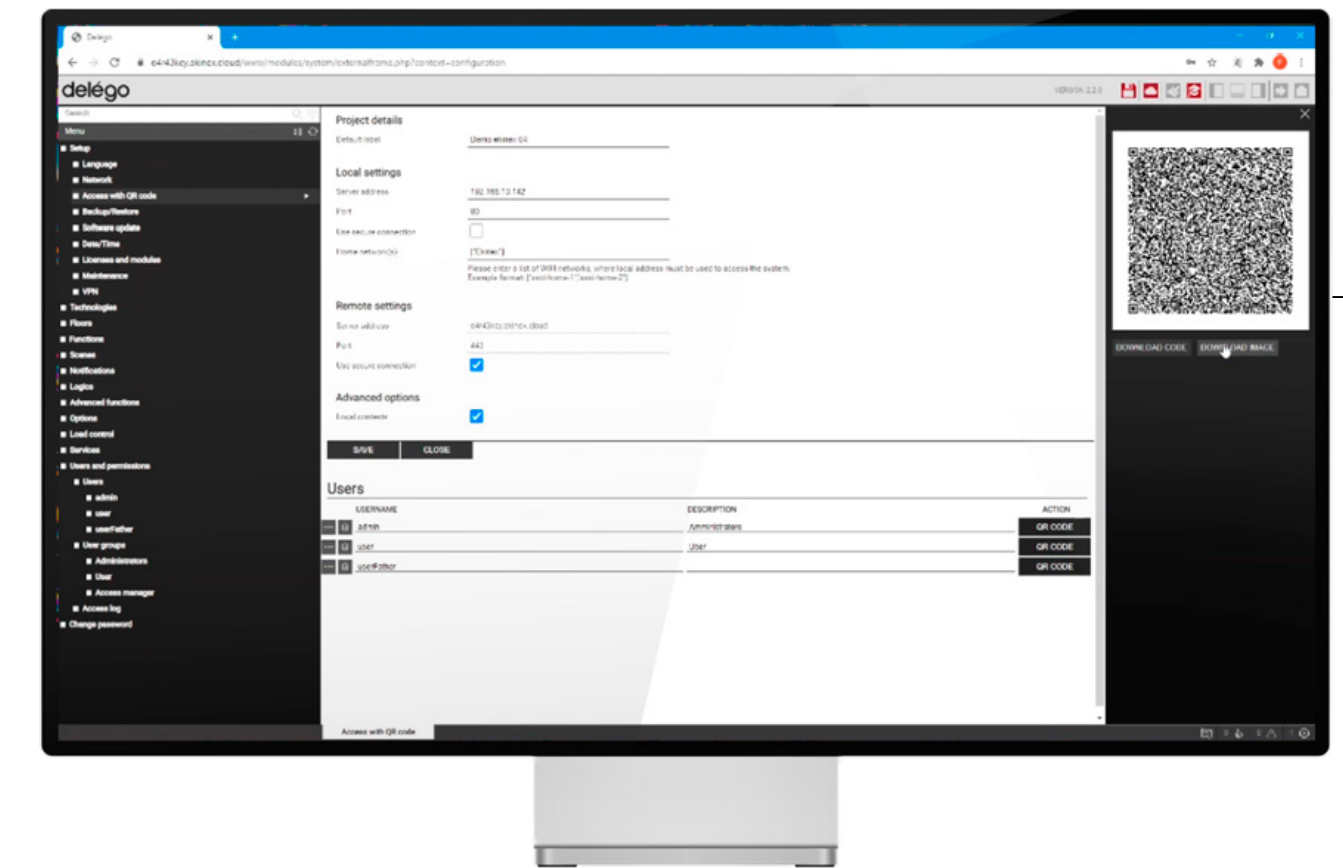

## NOTIFICATION CENTER

Centralized notification management provides real-time alerts for maintenance and security.

# SYSTEM INTEGRATION

## A FULLY CONNECTED HOTEL

Ekinex's open-standard platform (Delègo) ensures seamless integration with third-party systems, making automation more powerful and flexible



### PROPERTY MANAGEMENT SYSTEMS (PMS) INTEGRATION

Synchronizes guest check-in/out with room settings for a smooth experience.

For a complete list of PMS integration please refer to Ekinex Website.



### DOOR LOCK INTEGRATION

Works with leading electronic locks for a simplified control.

Availability 2026



### BMS INTEGRATION (BACNET\*, MODBUS, KNX, DALI)

With native integration with KNX and Modbus, Delègo guarantees centralized building control for HVAC, security, lighting and maintenance.

Bacnet integration can be achieved with 3rd party gateways.



### 3rd PARTY HVAC INTEGRATION

Ensures compatibility with all major climate control systems.

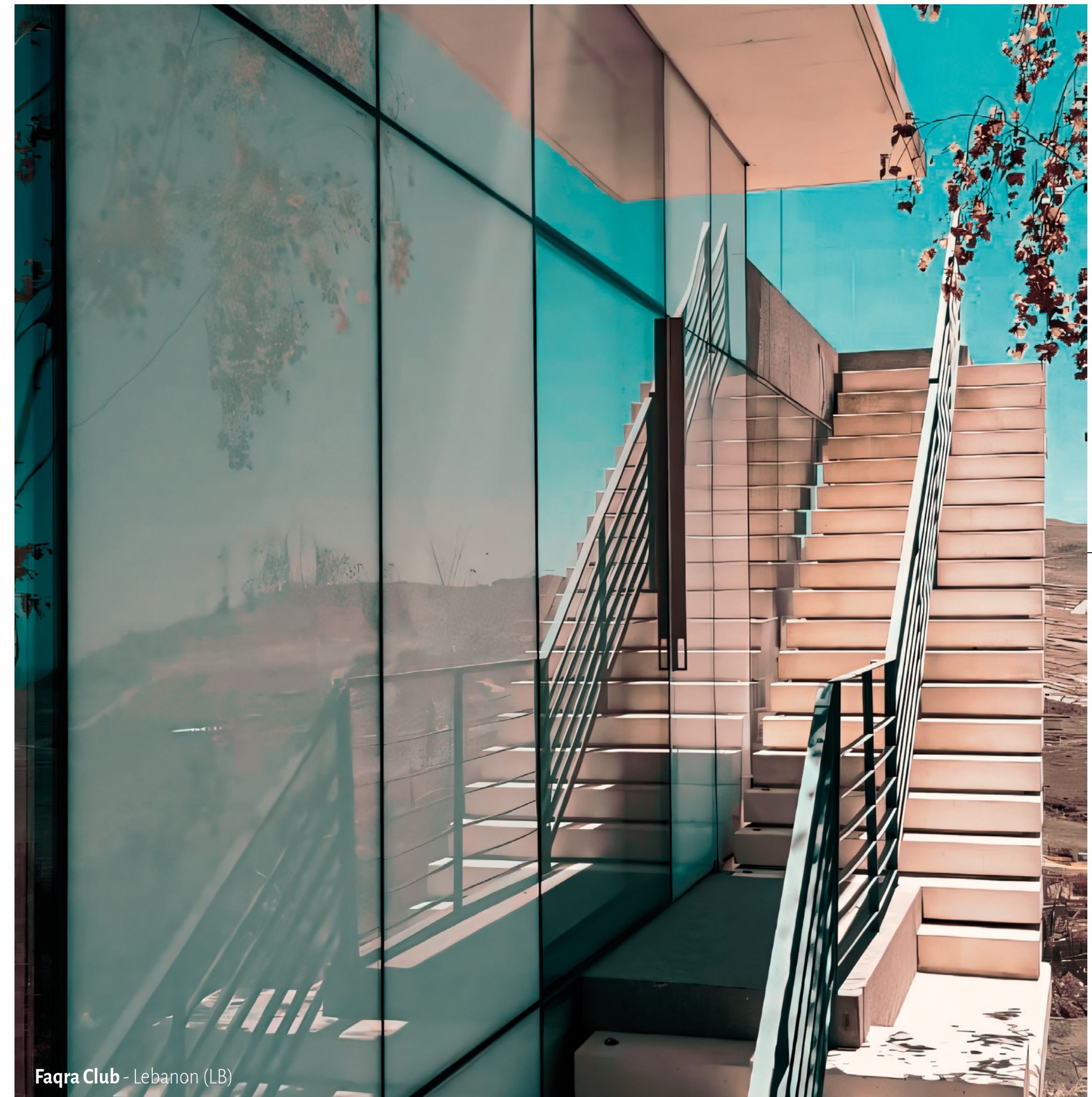

Faqra Club - Lebanon (LB)



# GUESTROOM MANAGEMENT

Modern hospitality demands efficient, intuitive, and fully integrated guestroom management solutions that enhance comfort, security, and energy efficiency.

The Ekinex guestroom control system combines advanced automation with seamless integration into PMS, BMS, access control, and workflow management software, ensuring a high-performing, centralized, and guest-centric experience.

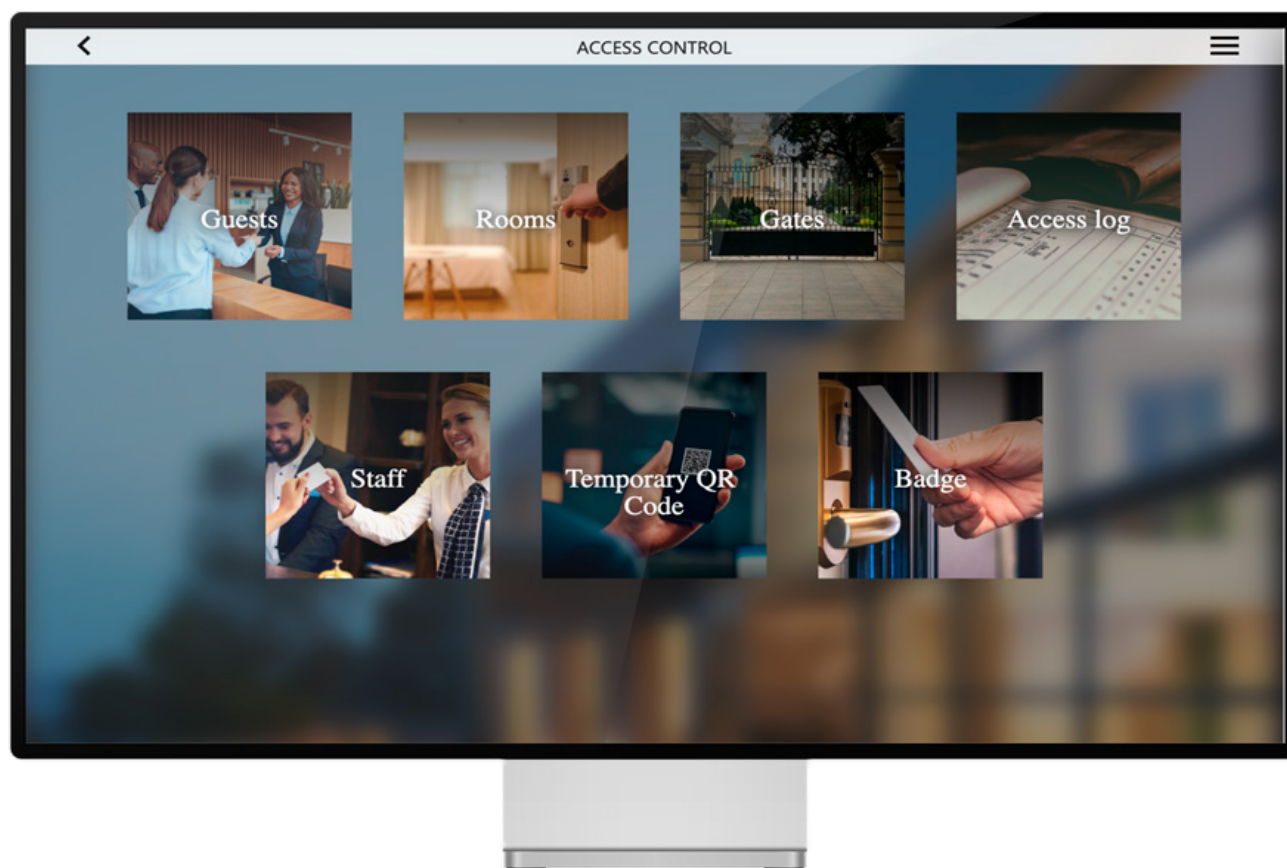

## ACCESS CONTROL MANAGEMENT

KNX-based RFID Access Control: secure, seamless room entry with keycards. Keyless Access (Bluetooth & NFC): guests can unlock rooms via their smartphone, reducing front desk interactions.

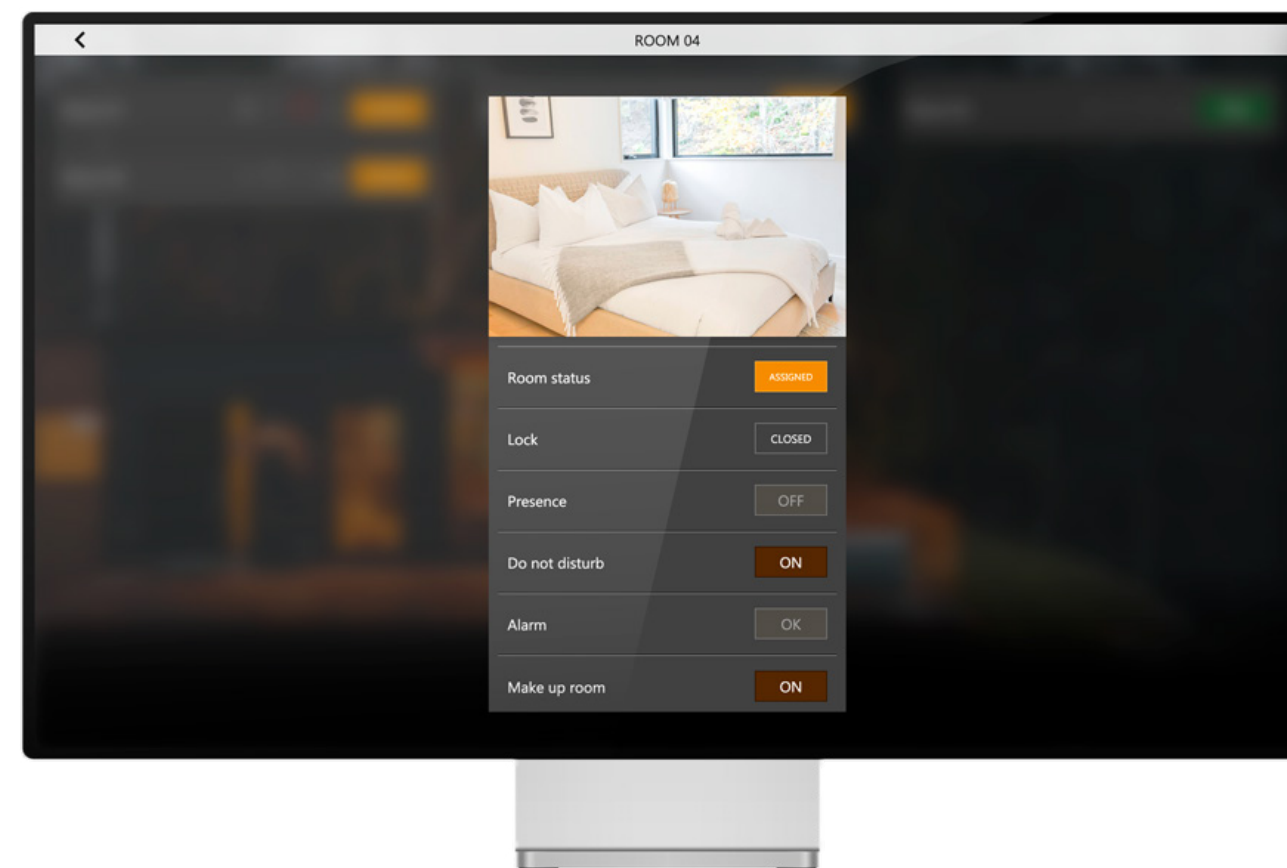

## ROOM DASHBOARD

Monitor and control Lighting, Climate, and Shades in the room. Control the room status, notifications and alarms, DND, MUR, and the presence of the guest in the room.

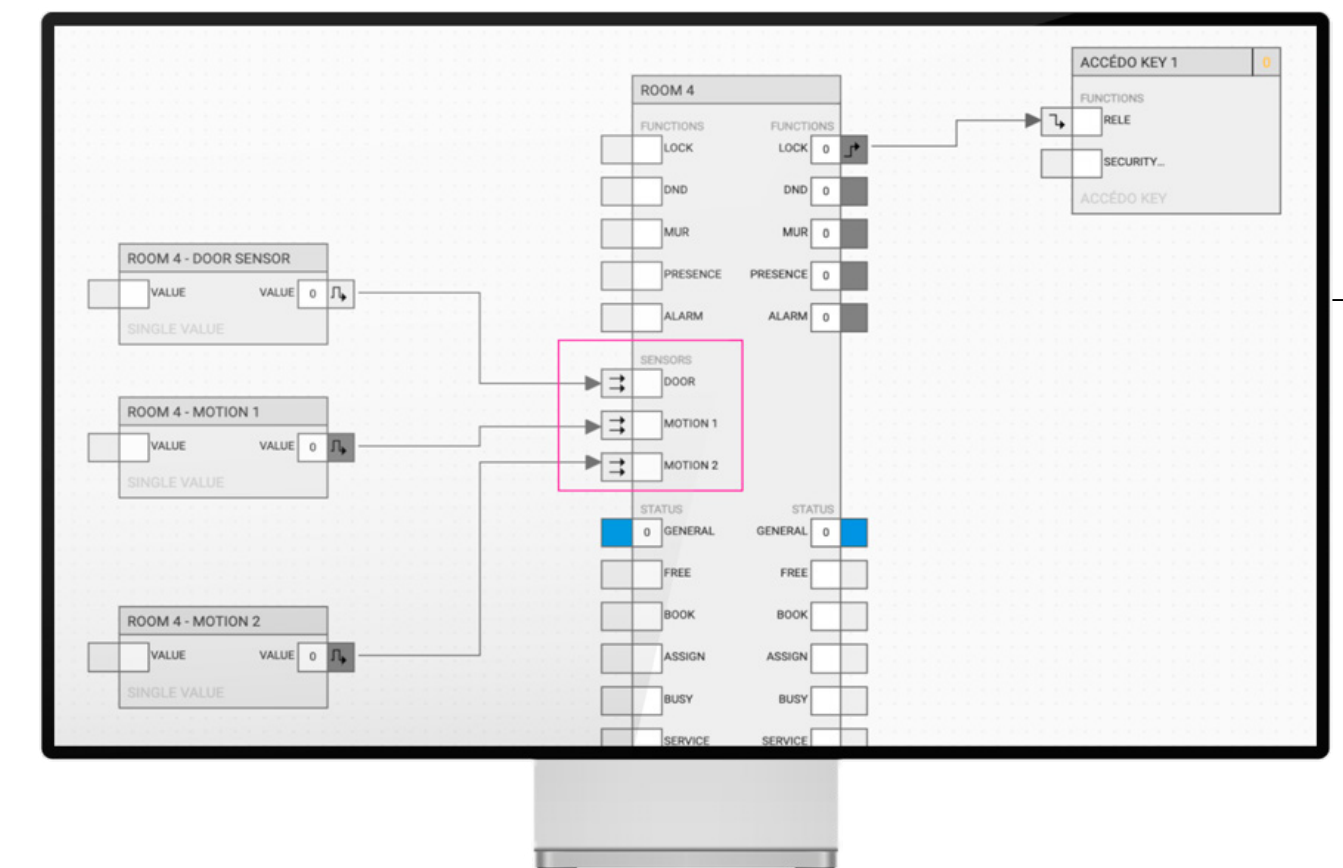

## VIRTUAL PRESENCE DETECTION

Automatically adjusts lighting, climate, and shades based on guest presence. Motion detection sensors and door contact are the most reliable solution for detecting presence in the room.

# GUESTROOM CONNECTIONS DIAGRAM

Example of an integrated system configuration that enables centralized management of room functions, providing the reception with real-time information on guest presence, curtain and shutter status, and room temperature control. The transponder card reader outside the door ensures security and efficiency. The system can be completed with a room controller and Ekinex DIN Rail modules to control fan coils, ON/OFF and DALI lights, blinds.

## PUSHBUTTON SERIES



## ACCESSORIES



## ACCESS CONTROL



## THERMOSTATS / ROOM CONTROLLERS



## DIN RAIL MODULES



## REVÉLO



## OCCUPANCY DETECTION

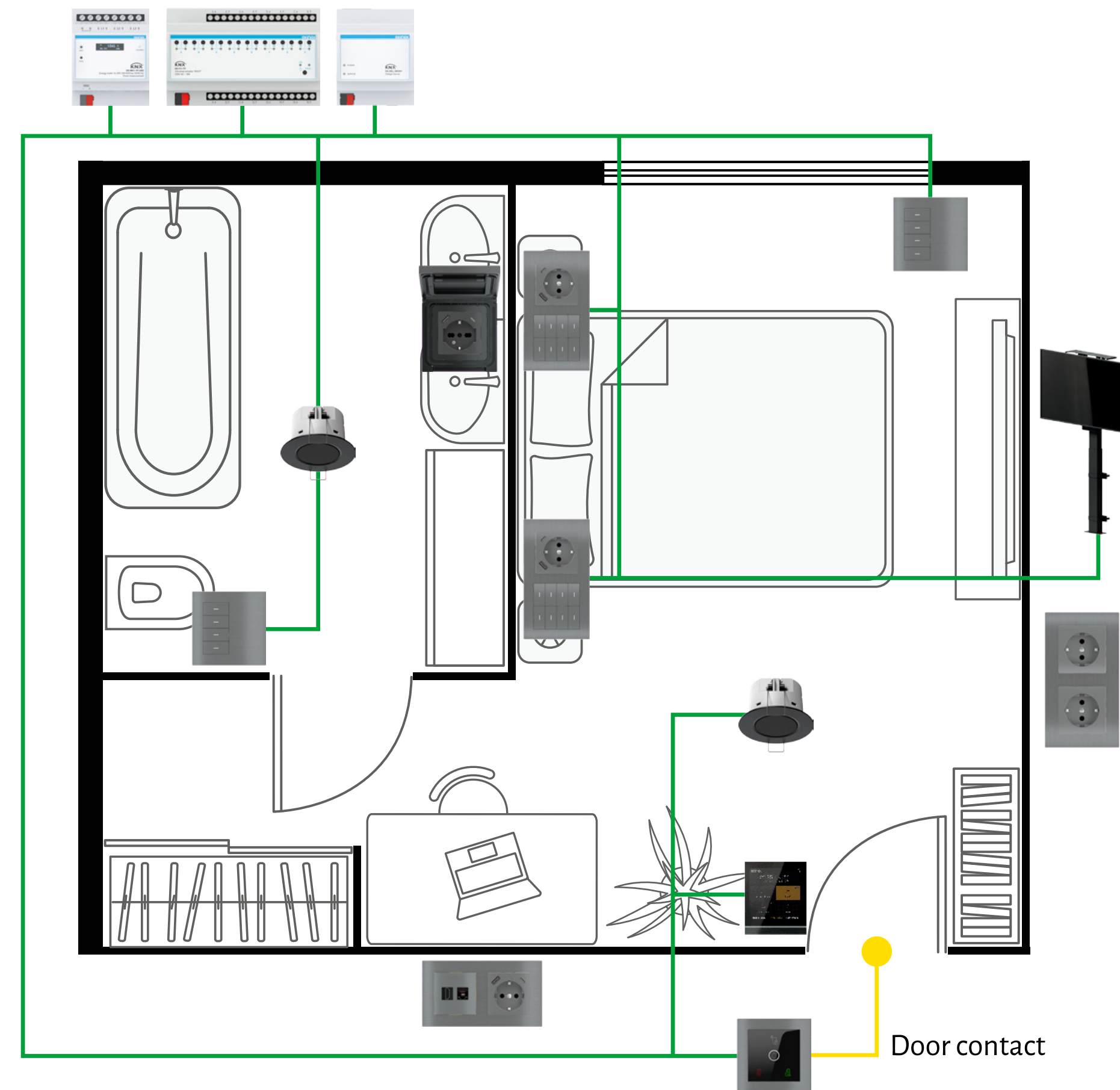

Function	Unsold	Sold check-in	Sold occupied - day	Sold occupied - night	Sold unoccupied
Light	off	off	Day first entry Welcome scene / Day Welcome scene or previous room status	Night first entry Welcome scene / Night Welcome scene or previous light status	off
Socket Line	off	off	on	on	off
Clima	Absence mode, hotel fixed setpoint	Eco mode, hotel fixed setpoint	Comfort mode, guest controlled setpoint	Comfort mode, guest controlled setpoint	Eco mode, hotel fixed setpoint
Blinds	Closed	Closed	Closed	Closed	Closed



Four Seasons Residence - Marrakech (MA)

# GUESTROOM MANAGEMENT FUNCTIONS

FEATURES		NO INTEGRATION	PMS INTEGRATION
Room status	Occupied/Unoccupied	•	•
	Sold/Unsold		•
Presence Detection	RFID Card Holder	•	•
	Virtual Presence Detection	•	•
Welcome Scenes Options	Guest Entry Scene	•	•
	Check-In Welcome Scene		•
	Time Related	•	•
Privacy/Service	Do Not Disturb/Make Up Room	•	•
PMS Integration	Guest Check In/Out and Privacy/Service informations		•
BMS Integration	Bacnet*, KNX and Modbus integration	•	•
Temperature Control Options	Local (room) and remote (reception) manual temperature control	•	•
	Check-In/Out temperature set		•
	Guest presence related temperature set	•	•

\*With Third party gateway

# ACCESS CONTROL DEVICES

## RFID CARD READER EK-TO2-TP

KNX access control device, can be installed in corridors to open the room door. It is connected to KNX bus, it's powered with an auxiliary 12-24VDC.



### FUNCTIONALITIES

- ▶ RFID Card Reader
- ▶ Door Contact
- ▶ Door Bell
- ▶ Corridor Plate (Optional)
- ▶ DND Backlit Sign
- ▶ MUR Backlit Sign
- ▶ RGB Led (Freely Programmable)

### TECHNICAL DATA

- ▶ 13,56MHz RFID Card Reader
- ▶ 2 output relays (5A)
- ▶ 2 inputs for potential-free contacts
- ▶ 21-30 Vdc power supply via KNX bus
- ▶ SELV auxiliary power supply 12-30 Vdc and current consumption 20mA@30Vdc
- ▶ 1 capacitive door-bell button on the front
- ▶ 1 LED for DND, 1 green LED for MUR, 2 RGB LEDs
- ▶ Support of KNX data Secure protocol
- ▶ Compatible with Ekinex DEEP Series

## ACCÉDO KEY EK-ACC-KEY-IP

IP access control device, can be installed in corridors to open the room door. It is a PoE-powered and must be connected to the Ethernet network. It's IP65 so it can be installed also outdoor. Can be installed recessed (with an optional Back Box) or onwall.



### FUNCTIONALITIES

- ▶ RFID Card Reader
- ▶ PIN Code Backlit Keypad
- ▶ QR Code Reader
- ▶ Door Contact
- ▶ Feedback LED

### TECHNICAL DATA

- ▶ 13,56MHz and 125KHz RFID Card Reader
- ▶ 1 relay outputs (Dry Contact)
- ▶ 2 inputs for potential-free contacts
- ▶ RS485 port for safety relays
- ▶ RJ45 port, adaptive 10/100Mbps
- ▶ PoE or 12Vdc power supply
- ▶ IP65 & IK9 rating protection
- ▶ 140 x 50 x 27mm

# OCCUPANCY DETECTION DEVICES

## RFID CARD HOLDER EK-T12-TP

Can be installed inside the room, to activate the loads (HVAC, sockets, lights). It is connected to KNX bus, it's powered with an auxiliary 12-24VDC.



### FUNCTIONALITIES

- ▶ RFID Card Reader
- ▶ Loads Contact
- ▶ Aux OUT contact
- ▶ Input for external DND pushbutton
- ▶ Input for external MUR pushbutton

### TECHNICAL DATA

- ▶ 13,56MHz RFID Card Reader
- ▶ 2 outputs relay (5A)
- ▶ 2 inputs for potential-free contacts
- ▶ 21-30 Vdc power supply via KNX bus
- ▶ SELV auxiliary power supply 12-30 Vdc and current consumption 20mA@30Vdc
- ▶ 1 red LED, 1 green LED, 1 RGB LED
- ▶ Support of KNX data Secure protocol
- ▶ Compatible with Ekinex DEEP Series

## OCCUPANCY SENSOR EK-SG2-TP-P / EK-SG2-TP-M

In combination with the door contact and the Virtual Presence Logic on Delégo Server can determine the real presence of the guest in the room and control HVAC and lights consequently. Despite its multiple functionalities, the presence sensor comes in an ultra-compact design that is almost invisible in rooms.



### FUNCTIONALITIES

- ▶ Detection of normal and small movements with 24GHz microwave technology
- ▶ Up to 4 output channels and up to 3 brightness levels for both the start and end detection situation
- ▶ Brightness sensor
- ▶ Ambient temperature sensor
- ▶ Air humidity sensor
- ▶ Constant brightness control
- ▶ Temperature control functions
- ▶ Advanced logic functions

### TECHNICAL DATA

- ▶ 360° static presence detection range up to 8.5m diameter (at 4m height)
- ▶ 21-30 Vdc power supply via KNX bus and 4mA@30Vdc current consumption
- ▶ SELV auxiliary power supply 12-30 Vdc and current consumption 20mA@30Vdc
- ▶ Illumination measurement range 0-2000 lux
- ▶ Support of KNX data Secure protocol
- ▶ Black and white options

# ACCESS CONTROL SOLUTION



# PUSHBUTTON SERIES





ACCESS CONTROL ARCHITECTURE

# STANDALONE ACCESS CONTROL SOLUTION

Standalone solution for residential and small business access control.

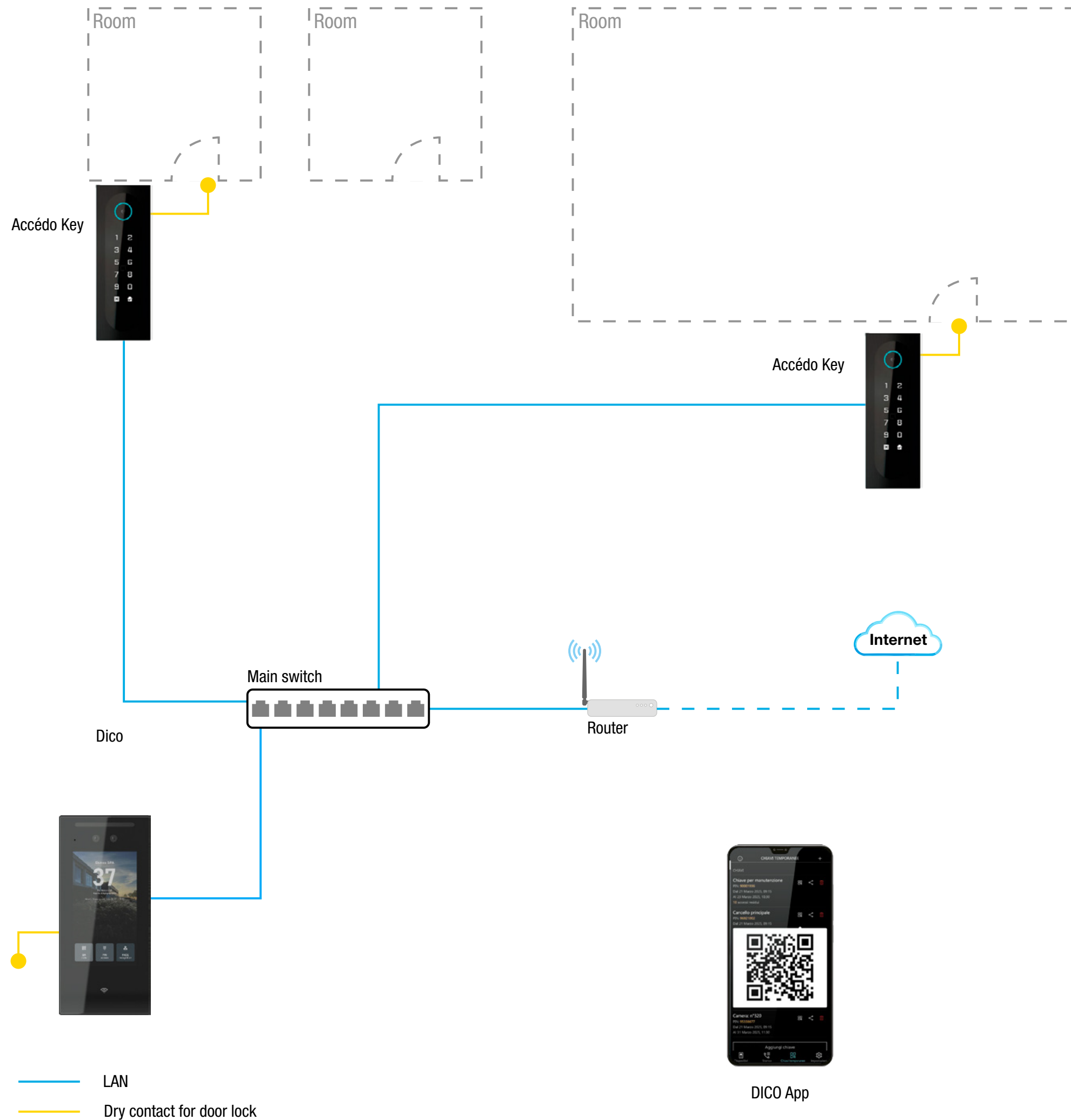

# SUGGESTED APPLICATIONS

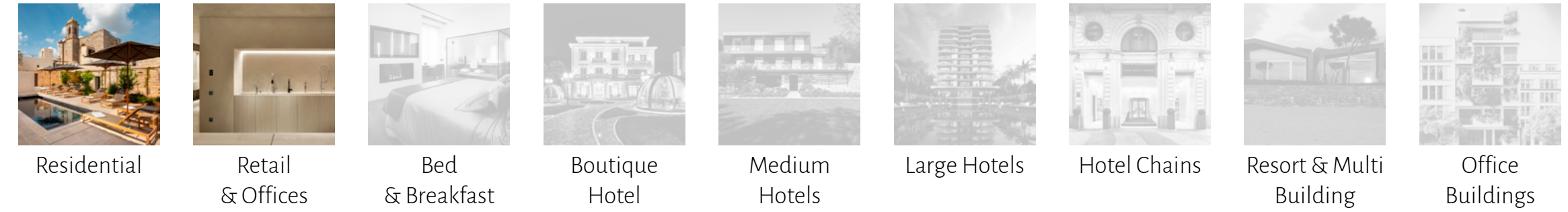

## KEY FEATURES

- ▶ Stand alone system, no need for external controller
- ▶ Ideal for residential and small retail projects
- ▶ Easy Installation
- ▶ Multiple access technologies
- ▶ All configuration & management from Dico App
- ▶ Ekinex Cloud Connection

## ACCESS TECHNOLOGIES

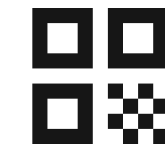

QR CODE

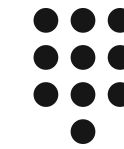

PIN CODE

## APP & SOFTWARE



## FUNCTIONS

- ▶ Intercom (only with Dico)
- ▶ Access Control

## PRODUCTS



Code **EK-CLD-VI**  
Description: **CLOUD LICENSE FOR APARTMENT**



Code **EK-ACC-KEY-IP**  
Description: **ACCÉDO KEY - IP ACCESS CONTROL READER**



Code **EK-5DP-VI**  
Description: **DICO - IP VIDEO INTERCOM**

# DICO APP

## KEY INFO

- ▶ Name
- ▶ Period of Validity
- ▶ PIN

## QR PREVIEW

- ▶ For direct access with DICO or ACCÈDO KEY

## SHARING

- ▶ Share the badge with QR Code via email, whatsapp or other apps.

## TOOLBAR

- ▶ Menu icon to access temporary keys section DICO APP

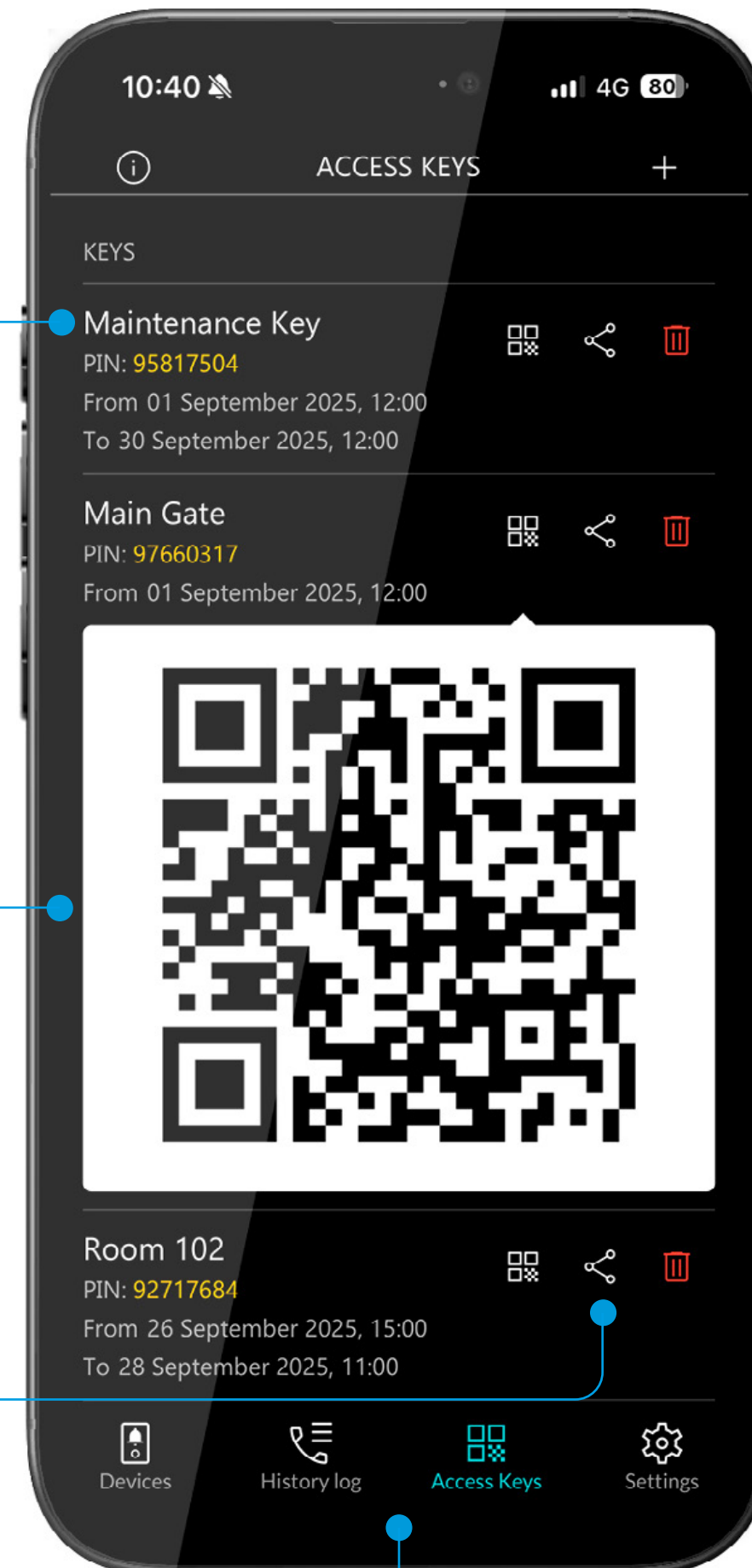

# DELÉGO ACCESS CONTROL SOLUTION

Delègo Server with Accédo Module Built-in, the perfect solution for B&B and small to medium size hotels.

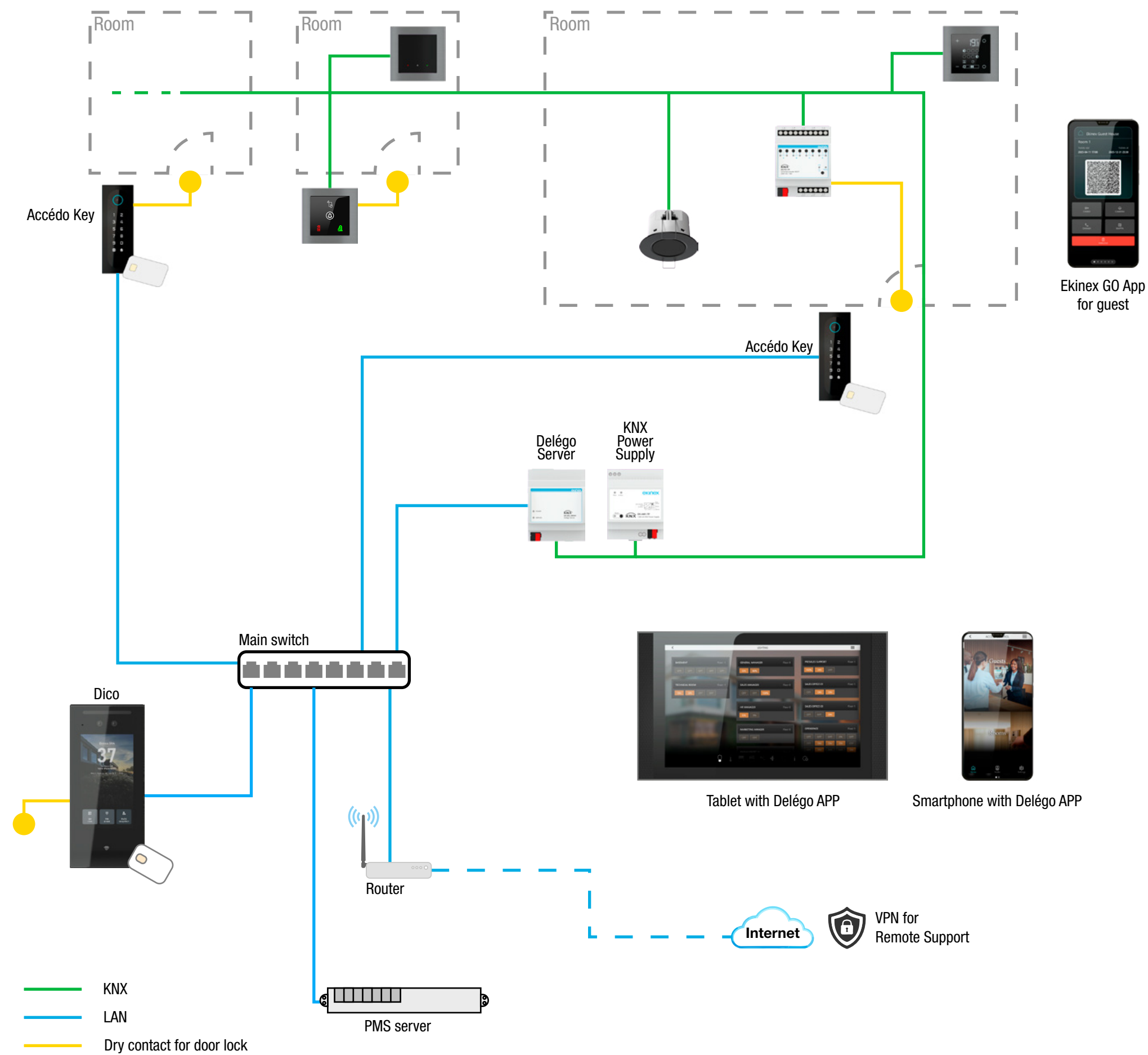

## SUGGESTED APPLICATIONS

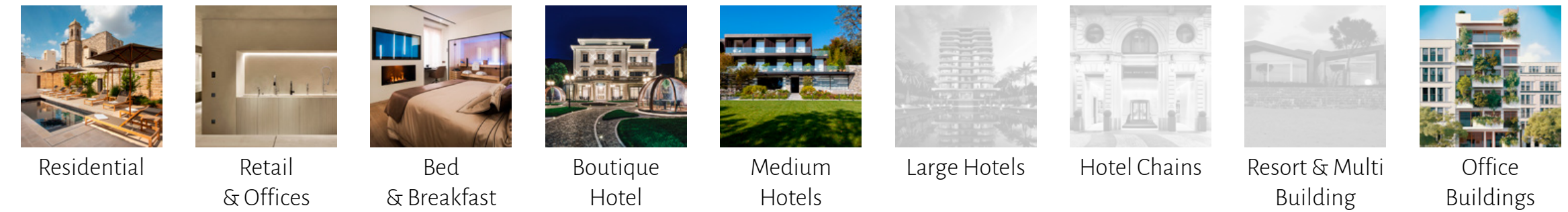

### KEY FEATURES

- ▶ All configuration & management from Delègo
- ▶ Ideal for small to medium size projects (up to 100 rooms)
- ▶ Access Control and Building Automation all in one
- ▶ Multiple access technologies
- ▶ Ekinex GO App for Guests
- ▶ Local and Remote Management

### ACCESS TECHNOLOGIES

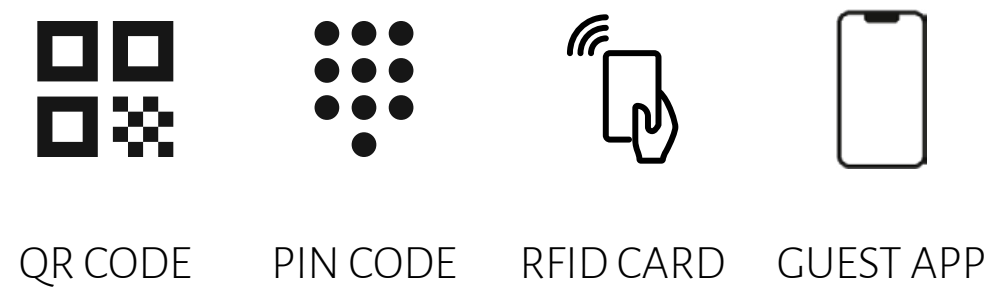

### APP & SOFTWARE

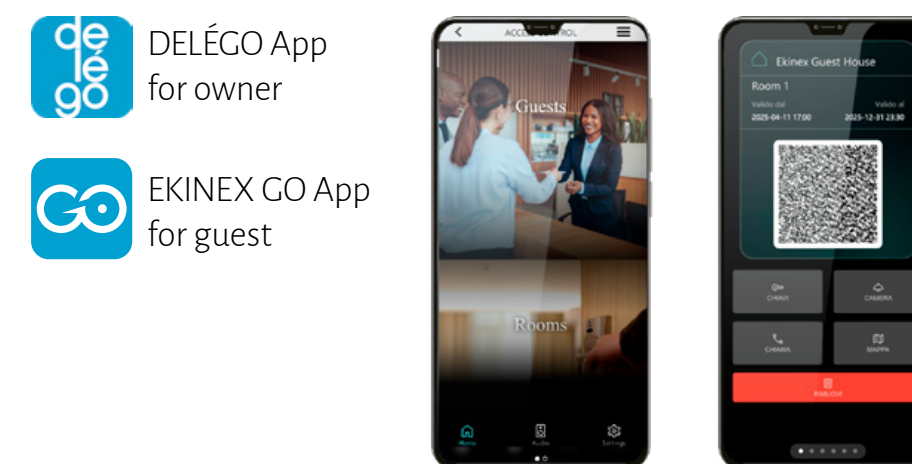

### FUNCTIONS

- ▶ Access Control
- ▶ Lights, temperature, shades, scenes control
- ▶ Virtual Presence Detection
- ▶ PMS Integration
- ▶ Energy Monitoring
- ▶ Notifications

### PRODUCTS

- Code **EK-ACC-Ro8**  
Description: 8 ROOM LICENCE FOR DELÉGO SERVER
- Code **EK-ACC-R12**  
Description: 12 ROOM LICENCE FOR DELÉGO SERVER
- Code **EK-ACC-R20**  
Description: 20 ROOM LICENCE FOR DELÉGO SERVER
- Code **EK-ACC-R50**  
Description: 50 ROOM LICENCE FOR DELÉGO SERVER
- Code **EK-ACC-R100**  
Description: 100 ROOM LICENCE FOR DELÉGO SERVER
- Code **EK-ACC-PMS01**  
Description: PMS INTEGRATION LICENSE
- Code **EK-DEL-SRV01 / EK-DEL-SRV01-M**  
Description: DELÉGO SERVER / DELÉGO SERVER MINI
- Code **EK-TO2-TP-B / EK-TO2-TP-W**  
Description: KNX RFID CARD READER
- Code **EK-TI2-TP-B / EK-TI2-TP-W**  
Description: KNX RFID CARD HOLDER
- Code **EK-ACC-KEY-IP**  
Description: ACCÉDO KEY - IP ACCESS CONTROL READER
- Code **EK-5DP-VI**  
Description: DICO - IP VIDEO INTERCOM

# DELÉGO APP

FOR OWNER



SMARTPHONE INTERFACE

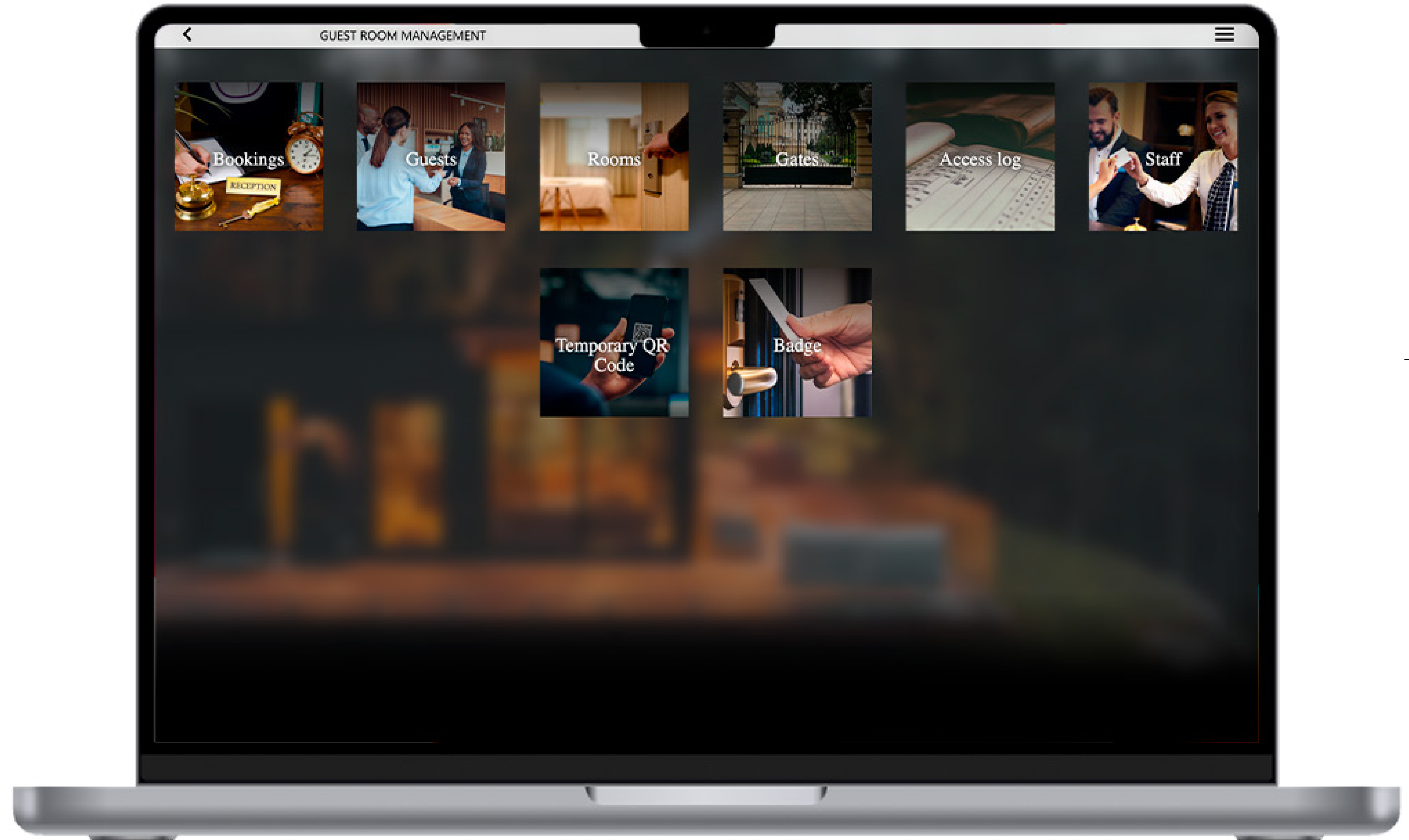

TABLET / DESKTOP INTERFACE

# DELÉGO APP

FOR OWNER

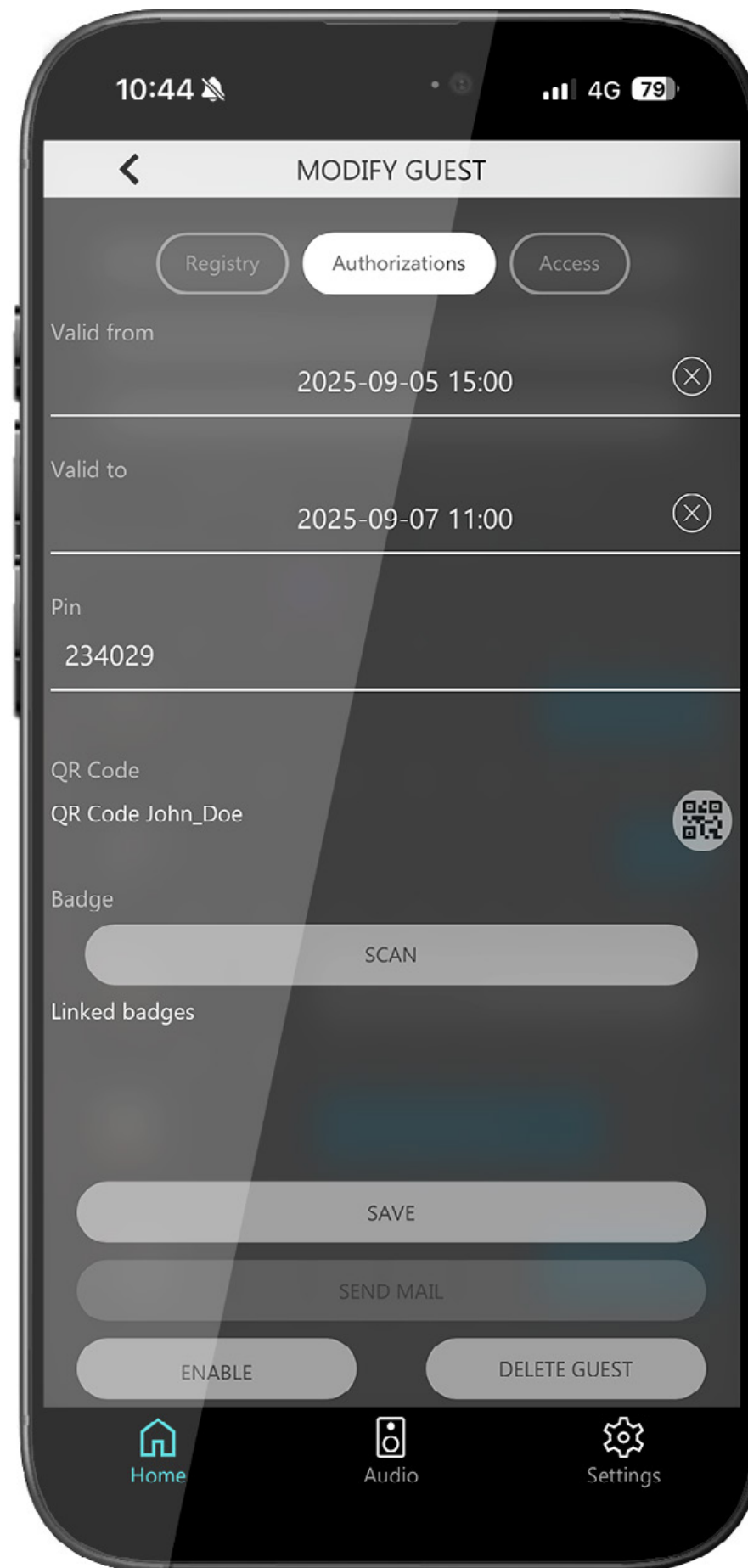

GUEST DETAIL

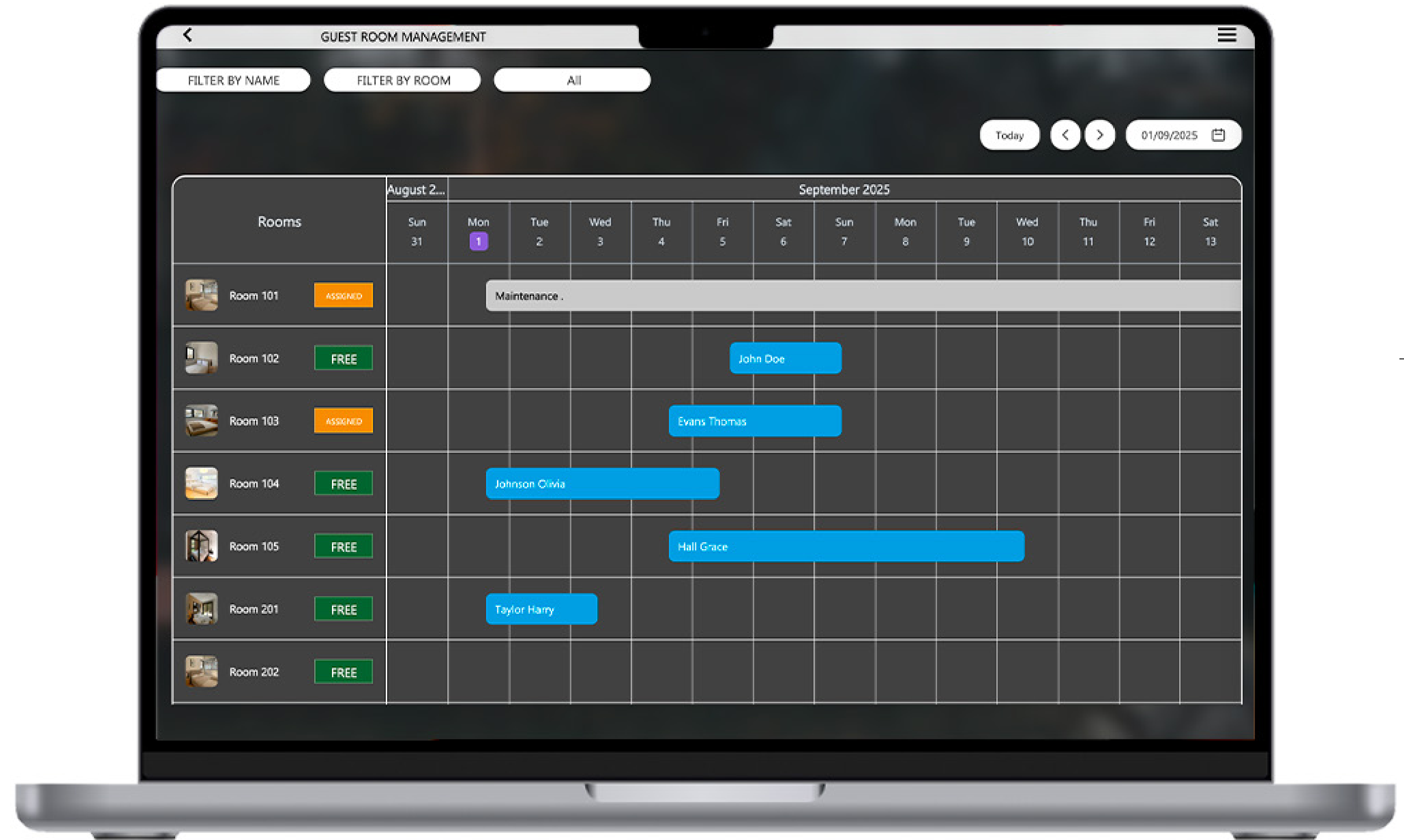

BOOKINGS PAGE

# EKINEX GO APP

FOR GUESTS



PROPERTY NAME

QR PREVIEW

- ▶ QR CODE to show in front DICO or ACCÈDO KEY to unlock the door

KEYS

- ▶ Menu with the list of locks (common spaces and booked room)

BOOKING DETAILS

ekinex

34

ROOM

- ▶ From this page the guest can manage temperature, scenarios shades, lights of his room

# ACCÉDO ACCESS CONTROL SOLUTION\*

Accédo software, the perfect solution for access control for large hotels and resorts.

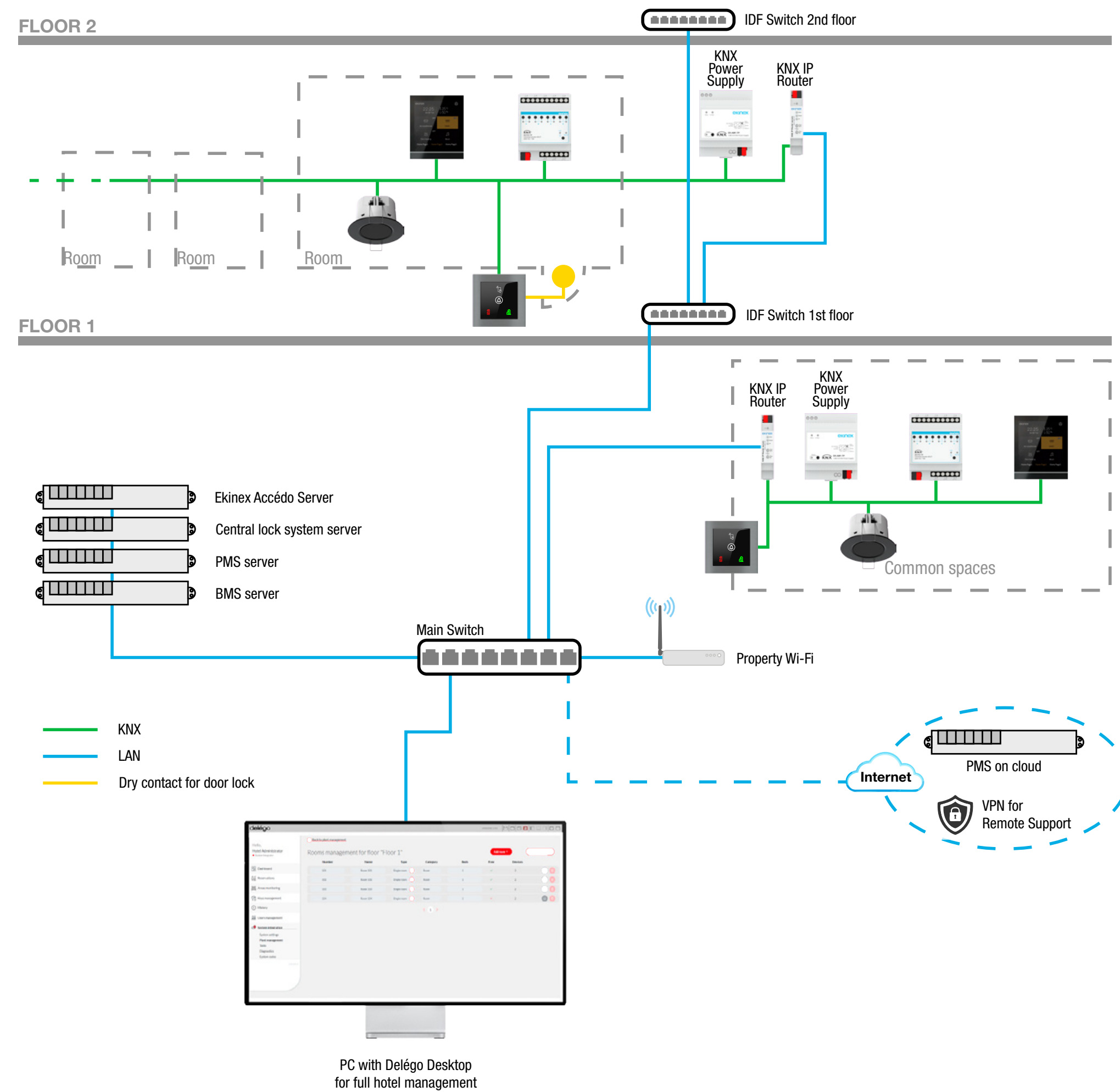

## SUGGESTED APPLICATIONS

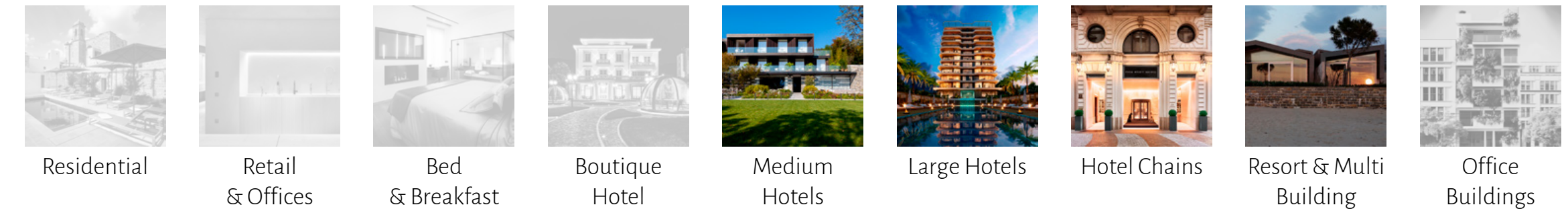

### KEY FEATURES

- ▶ All configuration & management from Accédo Software
- ▶ Centralized Main Server
- ▶ Ideal for Medium to large projects
- ▶ Reliable and scalable solution
- ▶ PMS Integration

### FUNCTIONS

- ▶ Access Control
- ▶ Lights, temperature, shades, scenes control
- ▶ PMS Integration
- ▶ Notifications

### ACCESS TECHNOLOGIES



RFID CARD

### APP & SOFTWARE

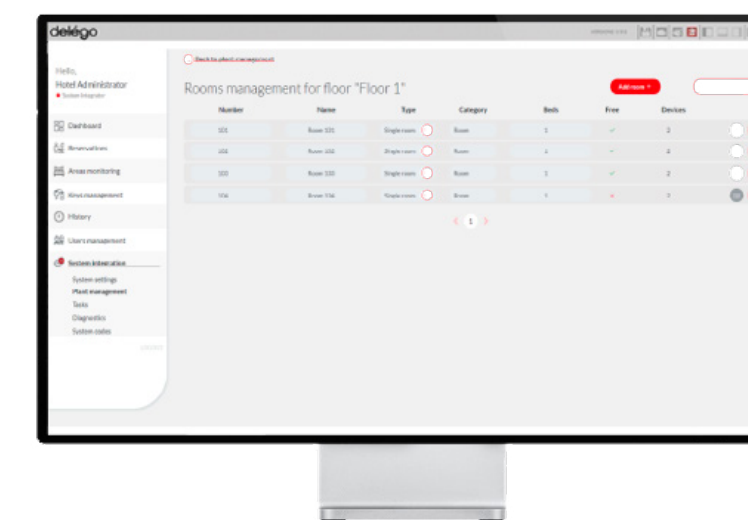

### PRODUCTS

- Code EK-ACC-50  
Description: ACCÉDO SOFTWARE 50 ROOMS
- Code EK-ACC-100  
Description: ACCÉDO SOFTWARE 100 ROOMS
- Code EK-ACC-200  
Description: ACCÉDO SOFTWARE 200 ROOMS
- Code EK-ACC-500  
Description: ACCÉDO SOFTWARE 500 ROOMS
- Code EK-ACC-PMS01  
Description: PMS INTEGRATION LICENCE
- Code EK-TO2-TP-B / EK-TO2-TP-W  
Description: KNX RFID CARD READER
- Code EK-T12-TP-B / EK-T12-TP-W  
Description: KNX RFID CARD HOLDER

\*Available 1st quarter 2026

# DELÉGO SUITE ACCESS CONTROL SOLUTION\*

The combination of Delégo Server and Accédo software, the perfect solution large hotels and resorts with full optionals.

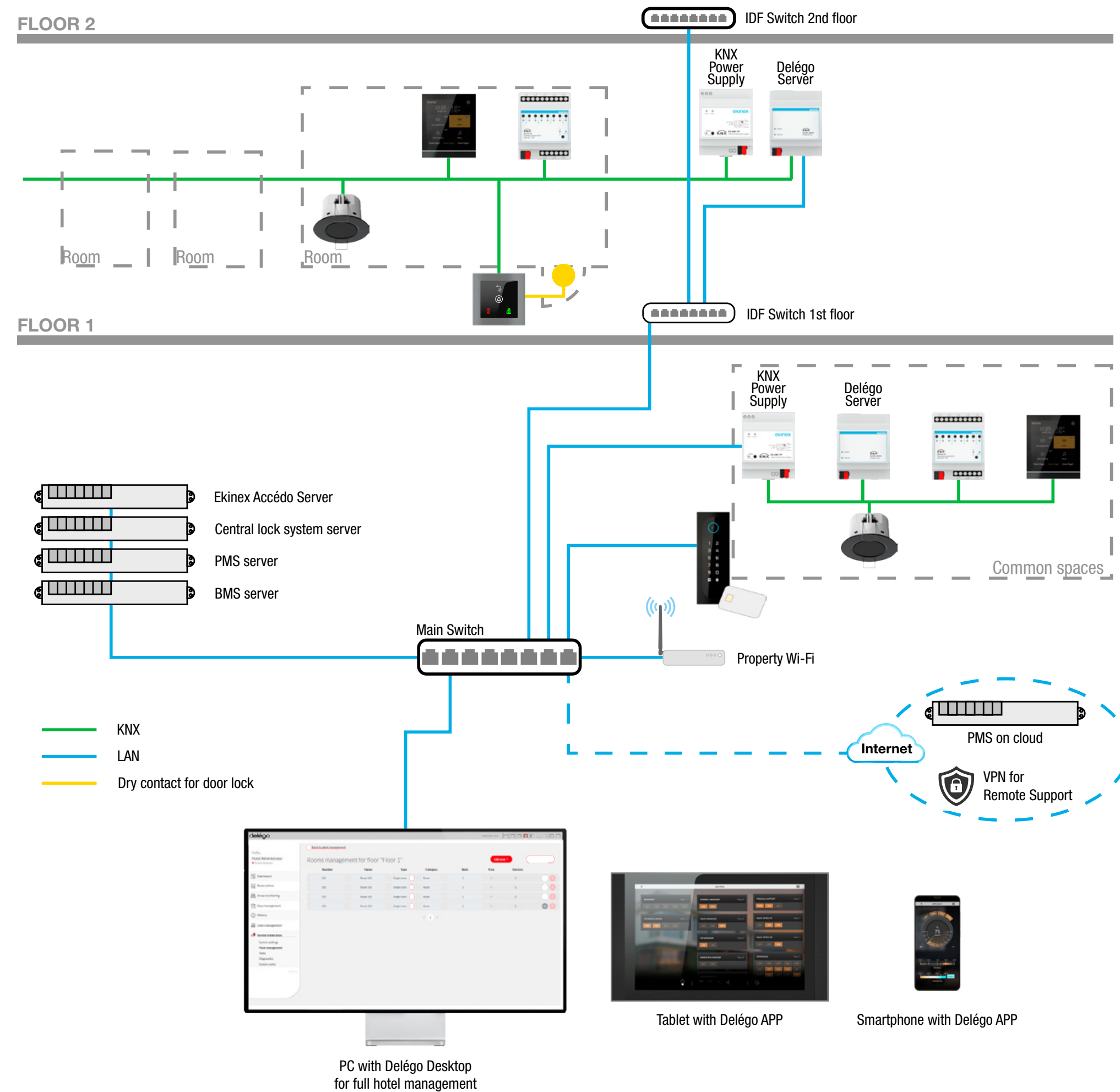

\*Available 2nd quarter 2026

## SUGGESTED APPLICATIONS

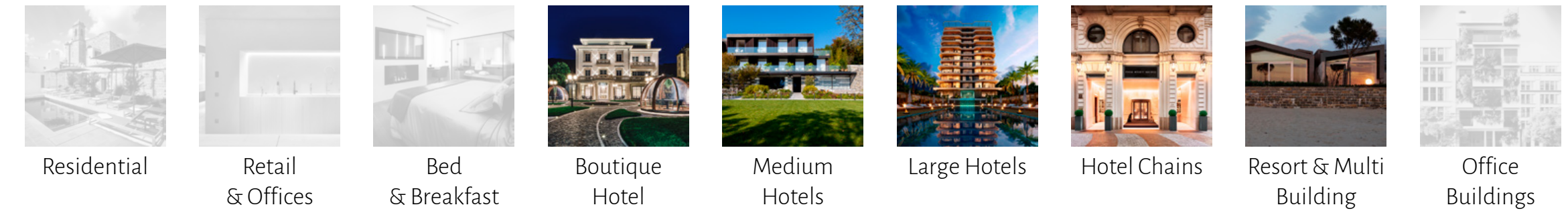

### KEY FEATURES

- ▶ All configuration & management from Delégo
- ▶ Access Control and Building Automation all in one
- ▶ Multiple access technologies
- ▶ Accédo App for Guests
- ▶ Local and Remote Management

### FUNCTIONS

- ▶ Access Control
- ▶ Lights, temperature, shades, scenes control
- ▶ Virtual Presence Detection
- ▶ PMS Integration
- ▶ Energy Monitoring
- ▶ Notifications

### ACCESS TECHNOLOGIES

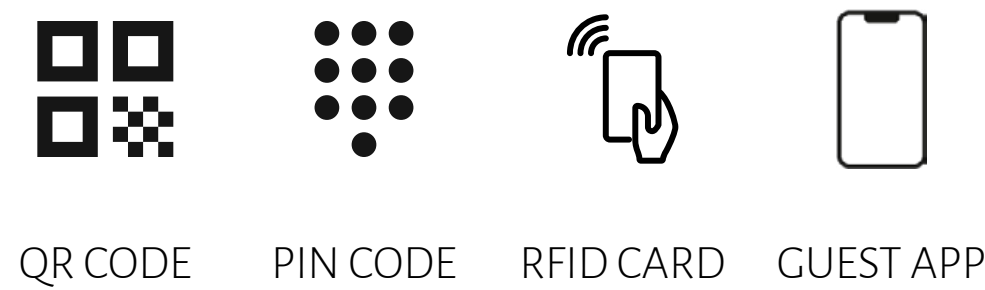

### APP & SOFTWARE

- DELÉGO Desktop Suite for owner
- DELÉGO App for owner
- EKINEX GO App for guest

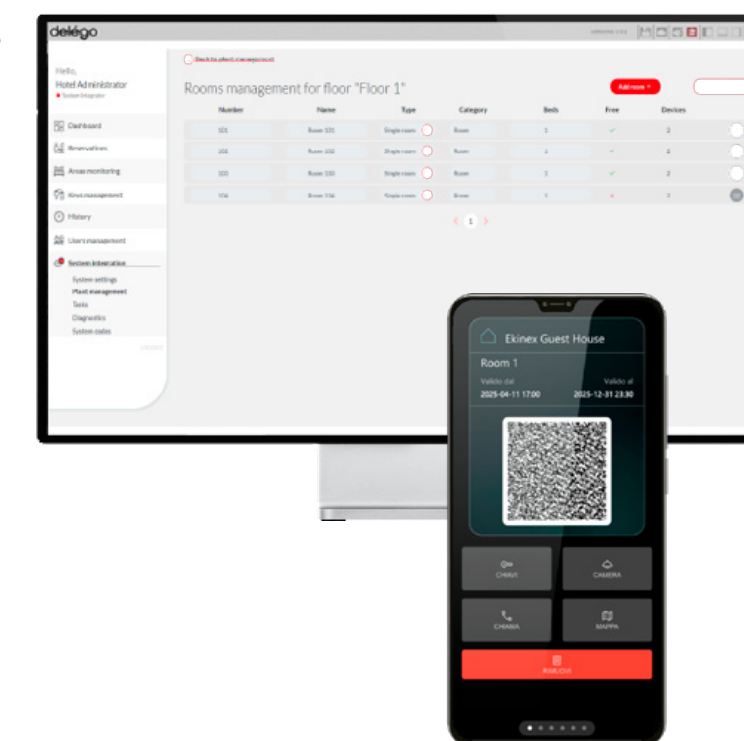

### PRODUCTS

- Code **EK-ACC-50**  
Description: ACCÉDO SOFTWARE 50 ROOMS
- Code **EK-ACC-100**  
Description: ACCÉDO SOFTWARE 100 ROOMS
- Code **EK-ACC-200**  
Description: ACCÉDO SOFTWARE 200 ROOMS
- Code **EK-ACC-500**  
Description: ACCÉDO SOFTWARE 500 ROOMS
- Code **EK-ACC-PMS01**  
Description: PMS INTEGRATION LICENCE
- Code **EK-DEL-SRV01 / EK-DEL-SRV01-M**  
Description: DELÉGO SERVER / DELÉGO SERVER MINI
- Code **EK-TO2-TP-B / EK-TO2-TP-W**  
Description: KNX RFID CARD READER
- Code **EK-TI2-TP-B / EK-TI2-TP-W**  
Description: KNX RFID CARD HOLDER
- Code **EK-ACC-KEY-IP**  
Description: ACCÉDO KEY - IP ACCESS CONTROL READER
- Code **EK-5DP-VI**  
Description: DICO - IP VIDEO INTERCOM

# TOOLS

Create, design, choose finishes  
and customise your installation  
with Ekinex design tools.

# SOME REFERENCES

*Our solutions in different sectors*

*Discover more on [ekinex.com](http://ekinex.com)*

**Tritone Luxury Suites** - Rome (IT)

**Wave Island** - Jesolo (IT)

**Dream Tower** - Cyprus (CY)

**Hotel Borgo dei Conti** - Perugia (IT)

**Chesa Fortuna** - St. Moritz (CH)

**Canaves Epitome Hotel** - Santorini (GR)

**Canaves Oia Hotel** - Santorini (GR)

**Four Season Residence** - Marrakech (MA)

**Mercury Tower** - St Julian's (MA)

**Boutique Hotel** - Stresa (IT)

**Vaya Beach Resort** - Irakli (BG)

**Faqra Clab** - Lebanon (LB)

**Golden Tulip Hotel** - Riyadh (SA)

**Laqua By The Lake** - Pettenasco (IT)

**I Tre Bacili** - Spongano (IT)

**Park Hyatt** - Milan (IT)

**Periyali Villas Beach Resort** - Cyprus (CY)

**Lo Scudo di Stabio** - Stabio (CH)

**Parcolago** - Lugano (CH)

**Hotel Galarej** - Serralunga d'Alba (IT)

*Ekinex S.p.A.*  
*Via Novara, 37*  
*I-28010 Vaprio d'Agogna NO - ITALY*  
*T +39 0321 1828980*  
*info@ekinex.com*  
*www.ekinex.com*