

*Shelly*

Explore the  
POSSIBILITIES

# PRODUCT CATALOGUE

SMART HOME & FACILITY AUTOMATION

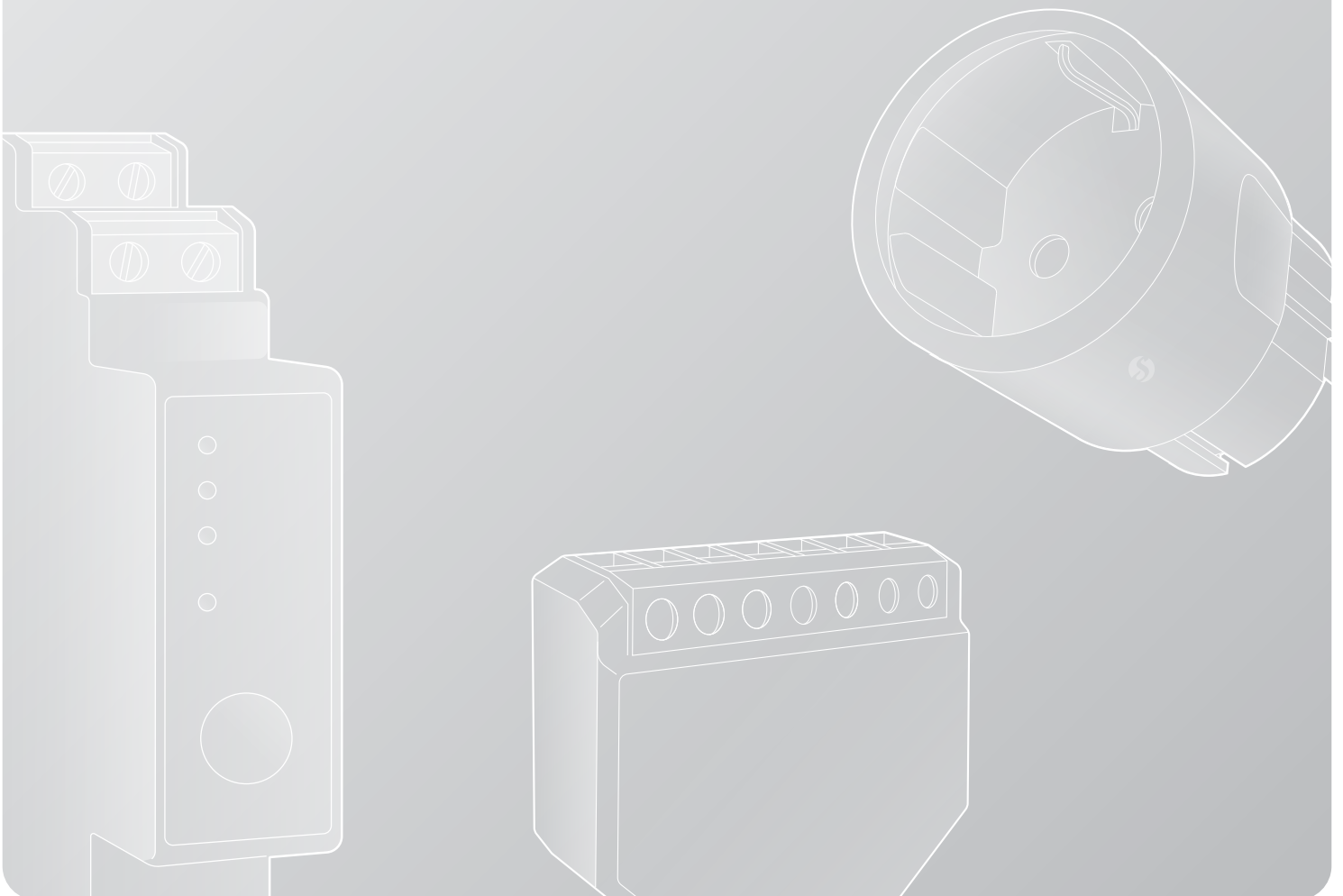
# Make your home and facility smart

Shelly is a line of home automation devices that allows customers to control their home directly through a mobile phone or with a preferred home assistant. Shelly's devices are retrofit, which makes them suitable for every electrical installation with no need of additional changes or improvements.

## With Shelly you can:

- Control the lights by adjusting brightness, colors, and set custom schedules.
- Control the home appliances or office equipment from anywhere.
- Save energy and money with precise power metering.
- Set custom automation features.
- Monitor temperature, humidity, and brightness.
- Receive immediate notifications in case of any status changes.
- Power consumption control

All Shelly devices are designed to offer maximum comfort of living, safety and easy installation.



# Global structure





# Shelly Smart Control



Easy device inclusion

Custom dashboards

Smart schedules & scenes

Compatible with Alexa

Energy monitoring

Electricity bills control

 Premium

  
AI Models

  
Offline Device Notifications

  
Virtual Devices

# Integrations

## Voice Assistants



## Home Automation Platforms



Home Assistant



Homey



openHAB



Domoticz



ioBroker



Node-RED



Symcon



Nymea



Hubitat



HomeSeer

## Protocols & APIs



MQTT



REST API



CoAP



mDNS



HTTP/HTTPS



Matter

Supported for Gen3 & Gen4 devices



Zigbee

Supported from Gen4 devices

KNX net/IP Integration



Tasmota



ESPHome



Control4



Crestron



URC

# Typically Used For...



Lights



Heating & Cooling



Appliances



Doorbell



Irrigation



Garage Door



Pool automation



Power monitoring



Floor heating



Water manifolds



Cover & Blinds



Load shedding



Valves



Energy monitoring



Energy saving



Photovoltaic



Electric chargers



No neutral installation



Dimming



LED strips



Color



Scene activation



Room management



Centralized control



Thermostat



Motion detection



Leak & Gas detection



# Region standards

GLOBAL

Majority of markets

UK

United Kingdom

EU

European Union

ANZ

Australia + New Zealand

US

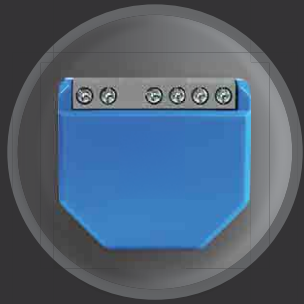
United States

IT

Italy



# Switch & Socket Box Types



60 mm

Depth 45-70 mm

EU Standard Wall Box

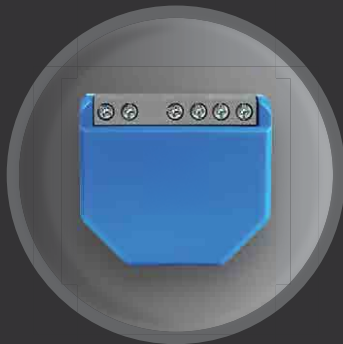


51 mm / 2"

76 mm / 3"

Depth 64-89 mm 2.5"-3.5"

US + Canada Gang Box



67 mm

Depth 35-40 mm

Danish Wall Box

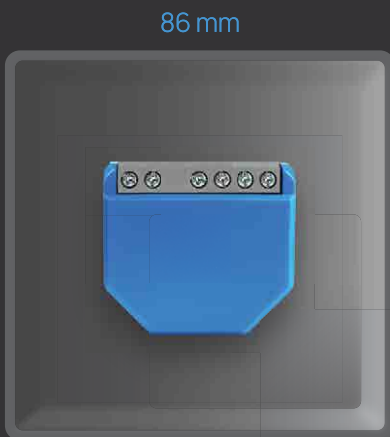


115 mm

75 mm

Depth 50 mm

Italian Box



86 mm

86 mm

Depth: 25 mm (shallow) or 35 mm (standard)

UK Back Box



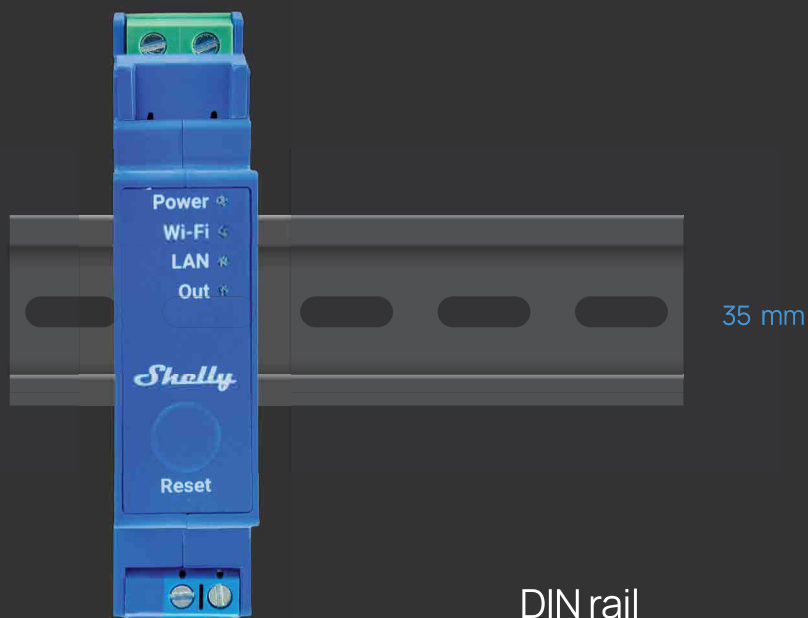
118 mm

74 mm

Depth ~50 mm

Australian / New Zealand Wall Box

# Pro devices on DIN rail



# Connectivity



Wi-Fi 4

Control and monitor your smart devices remotely without a hub using an existing Wi-Fi network.

**Frequency:** 2400 - 2483.5 MHz

**Max RF power:** < 20 dBm

**Operational range:**

- Up to 30 m / 100 ft indoors
- Up to 50 m / 160 ft outdoors



Wi-Fi 6

Control and monitor your smart devices remotely without a hub using an existing Wi-Fi network.

**Frequency:** 2401 - 2473 MHz

**Max RF power:** < 20 dBm

**Operational range:**

- Up to 30 m / 100 ft indoors
- Up to 50 m / 160 ft outdoors



Bluetooth 4.2

Add devices quickly and easily via Bluetooth, and enjoy fast, hassle-free setup without additional hubs.

**Frequency:** 2400 - 2483.5 MHz

**Max RF power:** < 4 dBm

**Operational range:**

- Up to 10 m / 100 ft indoors
- Up to 30 m / 160 ft outdoors



Bluetooth 5.0

Add devices quickly and easily via Bluetooth, and enjoy fast, hassle-free setup without additional hubs.

**Frequency:** 2402 - 2480 MHz

**Max RF power:** < 20 dBm

**Operational range:**

- Up to 10 m / 100 ft indoors
- Up to 30 m / 160 ft outdoors



Zigbee

Use a reliable, low-power Zigbee mesh network for extended coverage. A Zigbee hub is required.

**Protocol:** 802.15.4

**Frequency:** 2405 - 2480 MHz

**Max RF power:** < 20 dBm

**Operational range:**

- Up to 100 m / 328 ft indoors
- Up to 300 m / 984 ft outdoors



Z-Wave

Ensure a secure Sub-GHz smart home integration through a trusted Z-Wave network. A Z-Wave hub is required.

**Protocol:** Z-Wave

**Frequency:** 864 MHz [EU]; 912 MHz [US]; 919.8 MHz [ANZ]

**Max RF power:** < 25 mW

**Operational range:**

- Up to 80m / 262 ft indoors & up to 1 km / 1 mile outdoors



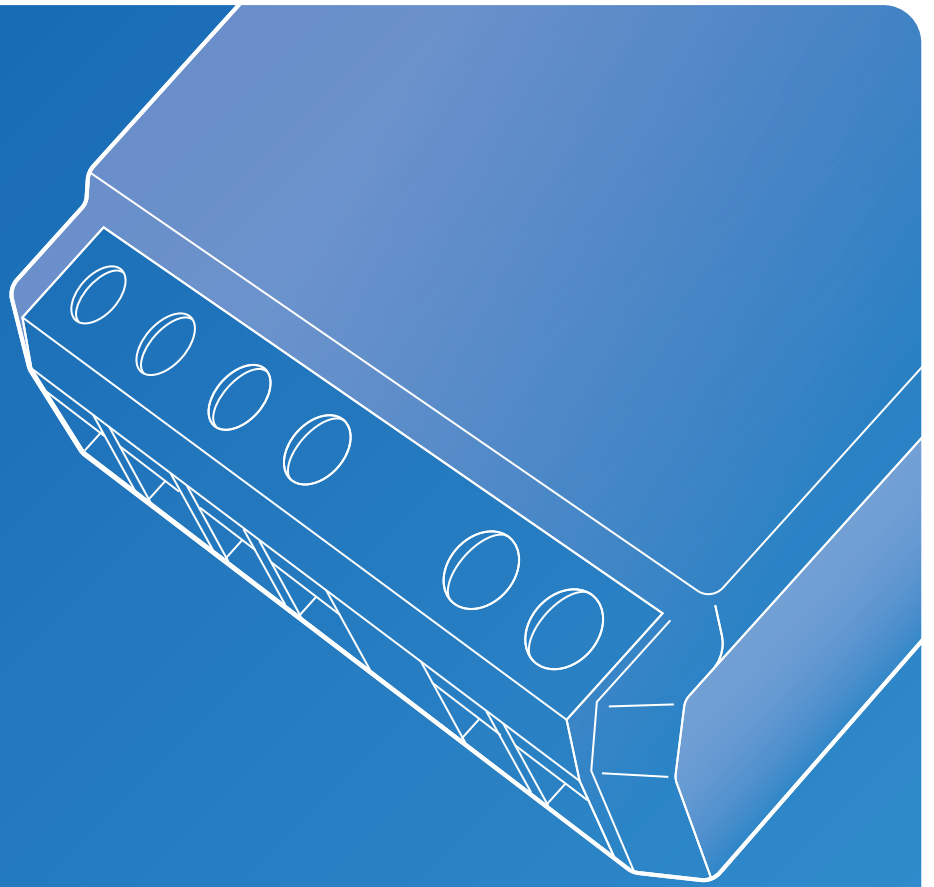
Matter

Integrate your Shelly devices into any major smart home platform like Apple, Google, or Alexa—no custom setup needed.



LAN

A wired, ultra-reliable connectivity



# 1 channel relays with dry contact

TYPICALLY USED FOR



Lights



Heating & Cooling



Appliances



Doorbell



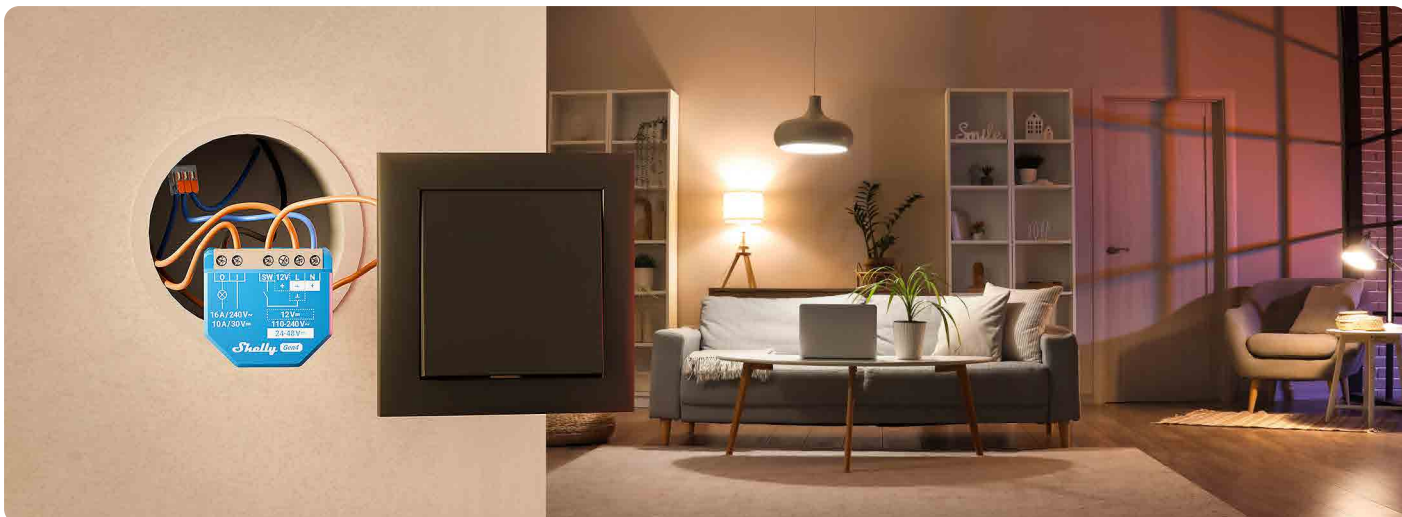
Irrigation



Garage Door



Pool automation



GLOBAL



### Shelly 1 Gen3



Power supply 110-240 V~ / 24-48 V== / 12 V==

Max load 16 A (240 V~); 10 A (30 V==)

Connectivity Wi-Fi 4  
Bluetooth 4.2

CPU ESP-Shelly-C38F

Flash Memory 8 MB

Size (HxWxD) 37x42x16 mm / 1.46x1.65x0.63 inch

Weight 26 g / 0.92 oz

Certifications RED, LVD, EMC, CE



[more info →](#)

GLOBAL



### Shelly 1 Gen4



Power supply 110-240 V~ / 24-48 V== / 12 V==

Max load 16 A (240 V~); 10 A (30 V==)

Connectivity Wi-Fi 6  
Bluetooth 5  
Zigbee 802.15.4

CPU ESP-Shelly-C68F

Flash Memory 8 MB

Size (HxWxD) 37x42x16 mm / 1.46x1.65x0.63 inch

Weight 26 g / 0.92 oz

Certifications RED, LVD, EMC, CE

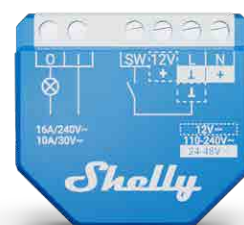


[more info →](#)

EU

US

ANZ



### Shelly Wave 1



Power supply 110-240 V~ / 24-48 V== / 12 V==

Max load EU: 16 A (240 V~); 10 A (30 V==); US: 15 A; ANZ: 16 A

Connectivity ZWLR  
US: 912 MHz  
Z-Wave Plus  
EU: 868.4 MHz  
US: 908.4 MHz  
ANZ: 919.8 MHz  
Z-Wave® S800

CPU

Size (HxWxD) 37x42x16 mm / 1.46x1.65x0.63 inch

Weight 26 g / 0.92 oz

Certifications RED, LVD, EMC, CE, FCC, SA, UL



[more info →](#)



GLOBAL



### Shelly 1 Mini Gen3



Power supply **110-240 V~**

Max load **8 A (240 V~); 5 A (30 V=)**

Connectivity **Wi-Fi 4**  
**Bluetooth 4.2**

CPU **ESP-Shelly-C38F**

Flash Memory **8 MB**

Size (HxWxD) **29x34x16 mm / 1.34x1.11x0.63 inch**

Weight **19 g / 0.65 oz**

Certifications **RED, LVD, EMC, CE**

[more info →](#)



GLOBAL



### Shelly 1 Mini Gen4



Power supply **110-240 V~**

Max load **8 A (240 V~) ; 5 A (30 V=)**

Connectivity **Wi-Fi 6**  
**Bluetooth 5**  
**Zigbee 802.15.4**

CPU **ESP-Shelly-C68F**

Flash Memory **8 MB**

Size (HxWxD) **29x34x16 mm / 1.34x1.11x0.63 inch**

Weight **19 g / 0.65 oz**

Certifications **RED, LVD, EMC, CE**

[more info →](#)



EU

US

ANZ



### Shelly Wave 1 Mini



Power supply **110-240 V~**

Max load **8 A (240 V~) ; 5 A (30 V=)**

Connectivity **ZWLR**  
**EU: 864 MHz**  
**US: 912 MHz**  
**Z-Wave Plus**  
**EU: 868.4 MHz**  
**US: 908.4 MHz**  
**ANZ: 919.8 MHz**  
**Z-Wave® S800**

CPU

Size (HxWxD) **29x34x16 mm / 1.34x1.11x0.63 inch**

Weight **19 g / 0.65 oz**

Certifications **RED, LVD, EMC, CE, FCC, SA**

[more info →](#)





GLOBAL

### Shelly Pro 1



- Power supply 110-240 V~
- Max load 16 A / 15 A UL Version
- Connectivity Wi-Fi 4  
Bluetooth 4.2  
LAN
- CPU ESP32-D0WDQ6
- Flash Memory 8 MB
- Size (HxWxD) 94x19x69 mm / 3.70x0.75x2.71 in
- Weight 63 g / 2.22 oz.
- Certifications RED, LVD, EMC, CE, UL, RCM



[more info →](#)



EU  
US  
ANZ

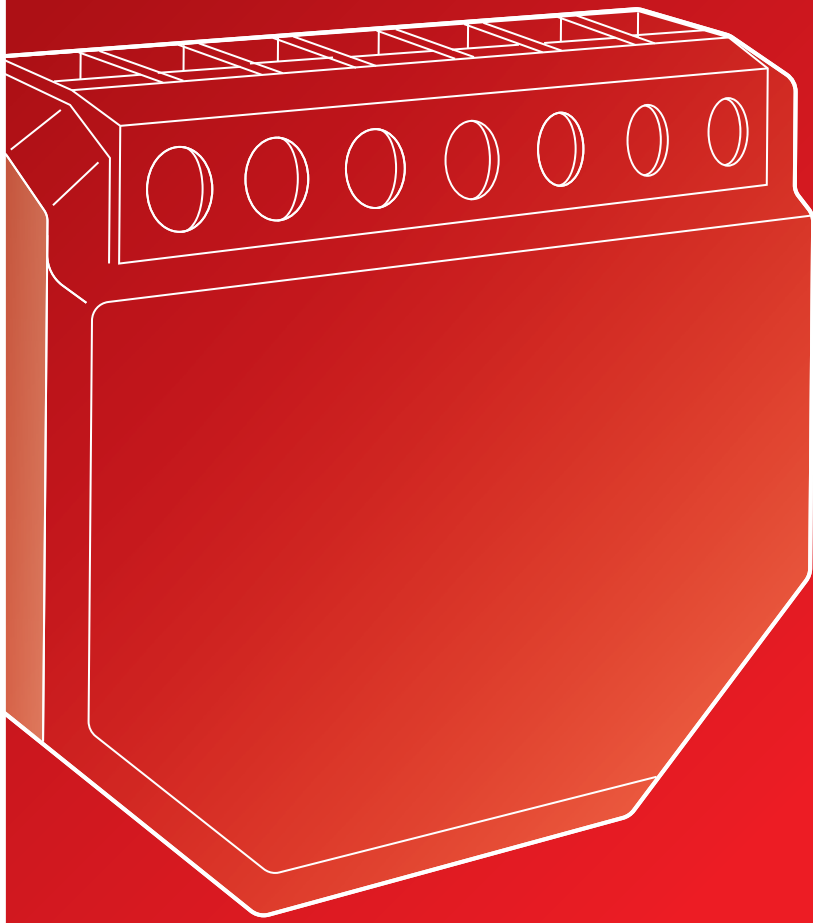
### Shelly Wave Pro 1



- Power supply 110-240 V~
- Max load EU/ANZ: 16 A (240 V~);  
US: 15 A
- Connectivity ZWLR  
US: 912 MHz  
Z-Wave Plus  
EU: 868.4 MHz  
US: 908.4 MHz  
ANZ: 919.8 MHz  
Z-Wave® S800
- CPU
- Size (HxWxD) 94x19x69 mm / 3.70x0.75x2.71 in
- Weight 60 g / 2.12 oz.
- Certifications RED, LVD, EMC, CE, RCM, FCC, SA



[more info →](#)



# 1 channel relays with power metering

TYPICALLY USED FOR



Power monitoring



Lights



Appliances



Floor heating



GLOBAL



### Shelly 1PM Gen3



Power supply 110-240 V~ / 24-30 V==

Max load 16 A (240 V~);  
10 A (30 V==)

Connectivity Wi-Fi 4  
Bluetooth 4.2

CPU ESP-Shelly-C38F

Flash Memory 8 MB

Size (HxWxD) 37x42x16 mm /  
1.46x1.65x0.63 inch

Weight 26 g / 0.92 oz

Certifications RED, LVD, EMC, CE



[more info →](#)

GLOBAL



### Shelly 1PM Gen4



Power supply 110-240 V~ / 24-30 V==

Max load 16 A (240 V~);  
10 A (30 V==)

Connectivity Wi-Fi 6  
Bluetooth 5  
Zigbee 802.15.4  
CPU ESP-Shelly-C68F

Flash Memory 8 MB

Size (HxWxD) 37x42x16 mm /  
1.46x1.65x0.63 inch

Weight 26 g / 0.92 oz

Certifications RED, LVD, EMC, CE



[more info →](#)

EU

US

ANZ



### Shelly Wave 1PM



Power supply EU/US: 110-240 V~ /  
24-30 V==; ANZ: 110-240 V~

Max load EU: 16 A (240 V~); 10 A  
(30 V==); US: 15 A; 10 A

Connectivity ZWLR  
US: 912 MHz  
Z-Wave Plus  
EU: 868.4 MHz  
US: 908.4 MHz  
ANZ: 919.8 MHz  
Z-Wave® S800  
CPU

Size (HxWxD) 37x42x16 mm /  
1.46x1.65x0.63 inch

Weight 26 g / 0.92 oz

Certifications RED, LVD, EMC, CE, FCC,  
SA, UL



[more info →](#)



GLOBAL



### Shelly 1PM Mini Gen3



Power supply 110-240 V~

Max load 8 A (240 V~)

Connectivity Wi-Fi 4  
Bluetooth 4.2

CPU ESP-Shelly-C38F

Flash Memory 8 MB

Size (HxWxD) 29x34x16 mm /  
1.34x1.11x0.63 inch

Weight 19 g / 0.65 oz

Certifications RED, LVD, EMC, CE

[more info →](#)



GLOBAL



### Shelly 1PM Mini Gen4



Power supply 110-240 V~

Max load 8 A (240 V~)

Connectivity Wi-Fi 6  
Bluetooth 5  
Zigbee 802.15.4

CPU ESP-Shelly-C68F

Flash Memory 8 MB

Size (HxWxD) 29x34x16 mm /  
1.34x1.11x0.63 inch

Weight 19 g / 0.65 oz

Certifications RED, LVD, EMC, CE

[more info →](#)



EU

US

ANZ



### Shelly Wave 1PM Mini



Power supply 110-240 V~

Max load 8 A (240 V~)

Connectivity ZWLR  
EU: 864 MHz  
US: 912 MHz  
Z-Wave Plus  
EU: 868.4 MHz  
US: 908.4 MHz  
ANZ: 919.8 MHz  
Z-Wave® S800

CPU

Size (HxWxD) 29x34x16 mm /  
1.34x1.11x0.63 inch

Weight 19 g / 0.65 oz

Certifications RED, LVD, EMC, CE, FCC, SA

[more info →](#)





GLOBAL



### Shelly Pro 1PM



Power supply 110-240 V~

Max load 16 A / 15 A UL Version

Connectivity Wi-Fi 4  
Bluetooth 4.2  
LAN

CPU ESP32-D0WDQ6

Flash Memory 8 MB

Size (HxWxD) 94x19x69 mm / 3.70x0.75x2.71 in

Weight 63 g / 2.22 oz.

Certifications RED, LVD, EMC, CE, UL, RCM

[more info →](#)



EU  
US  
ANZ



### Shelly Wave Pro 1PM



Power supply 110-240 V~

Max load EU/ANZ: 16 A (240 V~);  
US: 15 A

Connectivity ZWLR  
US: 912 MHz  
Z-Wave Plus  
EU: 868.4 MHz  
US: 908.4 MHz  
ANZ: 919.8 MHz  
Z-Wave® S800

CPU

Size (HxWxD) 94x19x69 mm / 3.70x0.75x2.71 in

Weight 60 g / 2.12 oz.

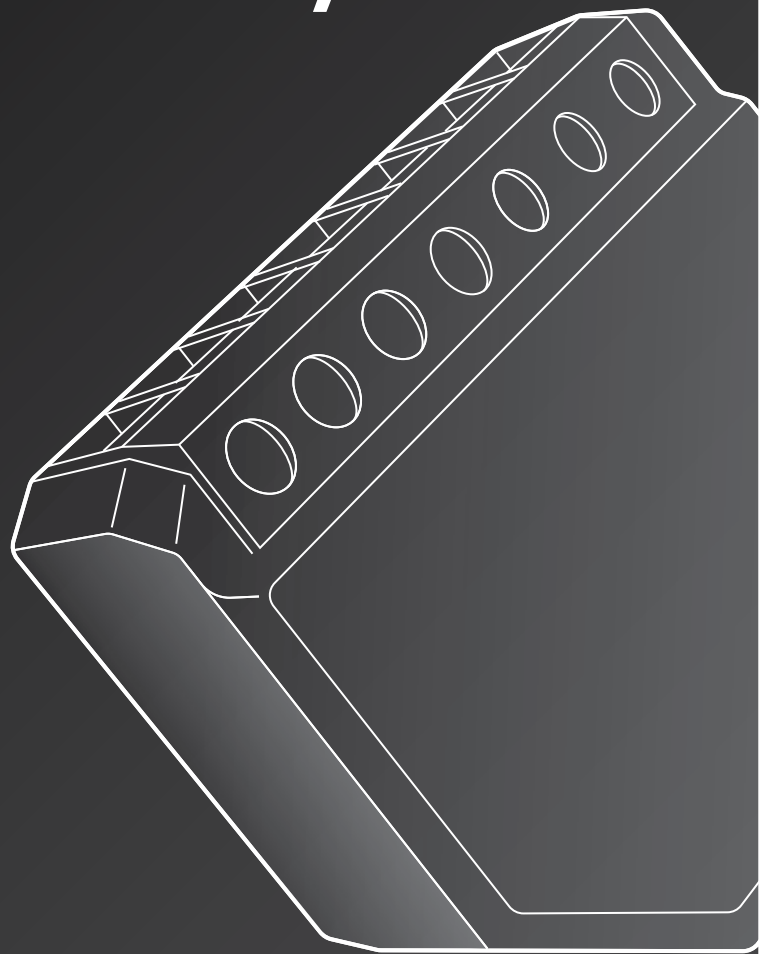
Certifications RED, LVD, EMC, CE, RCM, FCC, SA

[more info →](#)





# 2 channel relays



TYPICALLY USED FOR



Power monitoring



Cover & Blinds



Lights



Appliances



Irrigation



Floor heating



GLOBAL



## Shelly 2PM Gen3



Power supply 110-240 V~ / 24 V==

Max load 16 A (240 V~);  
10 A (30 V==)

Power metering **Yes**

Connectivity **Wi-Fi 4**  
**Bluetooth 4.2**

CPU **ESP-Shelly-C38F**

Flash Memory **8 MB**

Size (HxWxD) **37x42x16 mm /**  
**1.46x1.65x0.63 in**

Weight **30 g / 1.06 oz**

Certifications **RED, LVD, EMC, CE, RCM**



[more info →](#)

GLOBAL



## Shelly 2PM Gen4



Power supply 110-240 V~ / 24 V==

Max load 16 A (240 V~);  
10 A (30 V==)

Power metering **Yes**

Connectivity **Wi-Fi 6**  
**Bluetooth 5.0**

CPU **ESP-Shelly-C68F**

Flash Memory **8 MB**

Size (HxWxD) **37x42x16 mm /**  
**1.46x1.65x0.63 in**

Weight **30 g / 1.06 oz**

Certifications **RED, LVD, EMC, CE, RCM**



[more info →](#)

EU

US

ANZ



## Shelly Wave 2PM



Power supply **EU: 110-240 V~ / 24 V==**  
**ANZ: 110-240 V~**  
**US: 120 V~**

Max load **EU/ANZ: 10 A/channel,**  
**16 A total (240 V~)**  
**EU: 10 A (30 V==)**  
**US: 7 A per channel,**  
**14 A total (120 V~)**

Power metering **Yes**

Connectivity **ZWLR**  
**US: 912 MHz**  
**Z-Wave Plus**

**EU: 868.4 MHz**  
**US: 908.4 MHz**  
**ANZ: 919.8 MHz**  
**Z-Wave® S800**

CPU

Size (HxWxD) **37x42x16 mm /**  
**1.46x1.65x0.63 in**

Weight **29 g / 1,02 oz**

Certifications **RED, LVD, EMC, CE, RCM,**  
**FCC, SA, UL**



[more info →](#)



GLOBAL



### Shelly Shutter



- Power supply 110-240 V~ 50/60 Hz
- Max load 4 A for motors with compensated power factor (inductive loads)
- Power metering Yes
- Connectivity Wi-Fi 4  
Bluetooth 4.2
- CPU ESP-Shelly-C38F
- Flash Memory 8 MB
- Size (HxWxD) 37x42x16 mm / 1.46x1.65x0.63 in
- Weight 30 g / 1.06 oz
- Certifications RED, LVD, EMC, CE



[more info →](#)

EU  
US  
ANZ



### Shelly Wave Shutter



- Power supply EU: 110-240 V~  
ANZ: 110-240 V ~  
US: 120 V~
- Max load EU/ANZ: 10 A per channel, (240 V~)  
US: 7 A per channel, (120 V~)
- Power metering Yes
- Connectivity Z-Wave Plus  
EU: 868.4 MHz  
US: 908.4 MHz  
ANZ: 919.8 MHz  
Z-Wave® S800
- CPU
- Flash Memory 512 kB
- Size (HxWxD) 37x42x16 mm / 1.46x1.65x0.63 in
- Weight 29 g / 1,02 oz
- Certifications RED, LVD, EMC, CE, RCM, FCC, SA, UL



[more info →](#)

## 2 CHANNEL RELAYS



GLOBAL



### Shelly Pro 2PM



Power supply 110-240 V~

Max load 16 A per channel,  
25 A total /  
12.5 A UL Version

Power metering Yes

Connectivity Wi-Fi 4  
Bluetooth 4.2  
LAN

CPU ESP32-D0WDQ6

Flash Memory 8 MB

Size (HxWxD) 94x19x69 mm /  
3.70x0.75x2.71 in

Weight 76 g / 2.68 oz

Certifications RED, LVD, EMC, CE,  
UL, RCM



[more info →](#)

EU

US

ANZ



### Shelly Wave Pro 2PM



Power supply 110-240 V~

Max load EU/ANZ: 16 A/channel,  
25 A total;  
US: 12.5 A per channel,  
25 A total;

Power metering Yes

Connectivity ZWLR

EU: 864 MHz

US: 912 MHz

Z-Wave Plus

EU: 868.4 MHz

US: 908.4 MHz

ANZ: 919.8 MHz

Z-Wave® S800

CPU

Size (HxWxD) 94x19x69 mm /  
3.70x0.75x2.71 in

Weight 73 g / 2.58 oz.

Certifications RED, LVD, EMC, CE,  
RCM, FCC, SA



[more info →](#)

EU

US

ANZ



### Shelly Wave Pro Shutter



Power supply EU: 110-240 V~  
US: 120 V~  
ANZ: 110-240 V~

Max load EU/ANZ: 16 A/channel  
US: 12.5 A/channel

Connectivity ZWLR

EU: 864 MHz

US: 912 MHz

Z-Wave Plus

EU: 868.4 MHz

US: 908.4 MHz

ANZ: 919.8 MHz

CPU

Z-Wave® S800

Size (HxWxD) 94x19x69 ± 0.5 mm /  
3.70x0.75x2.71 ± 0.02 in

Weight 75 g / 2.65 oz.

Certifications RED, LVD, EMC, CE, RCM,  
FCC, SA



[more info →](#)

## 2 CHANNEL RELAYS



GLOBAL

### Shelly Pro 2



Power supply 110-240 V~

Max load 16 A / 12.5 A ULVersion

Power metering No

Connectivity Wi-Fi 4  
Bluetooth 4.2  
LAN

CPU ESP32-D0WDQ6

Flash Memory 8 MB

Size (HxWxD) 94x19x69 mm /  
3.70x0.75x2.71 in

Weight 76 g / 2.68 oz

Certifications RED, LVD, EMC, CE,  
UL, RCM



[more info →](#)



EU

US

ANZ

### Shelly Wave Pro 2



Power supply 110-240 V~

Max load EU/ANZ: 16 A per channel,  
25 A total;  
US: 12.5 A per channel,  
25 A total;

Power metering No

Connectivity ZWLR  
US: 912 MHz  
Z-Wave Plus

CPU EU: 868.4 MHz  
US: 908.4 MHz  
ANZ: 919.8 MHz  
Z-Wave® S800

Size (HxWxD) 94x19x69 mm /  
3.70x0.75x2.71 in

Weight 73 g / 2.58 oz.

Certifications RED, LVD, EMC, CE,  
RCM, FCC, SA



[more info →](#)



# 3+ channel relays

TYPICALLY USED FOR



Load shedding



Lights



Appliances



Valves



Heating & Cooling



GLOBAL



### Shelly Pro 3



- Power supply 110-240 V~
- Max load 16 A per channel, 48 A total
- Connectivity Wi-Fi 4  
Bluetooth 4.2  
LAN
- CPU ESP32-D0WDQ6
- Flash Memory 8 MB
- Size (HxWxD) 96x53x59 mm / 3.78x2.01x2.32 inch
- Weight 150 g / 5.29 oz
- Certifications RED, LVD, EMC, CE, RCM

more info →



EU  
US  
ANZ



### Shelly Wave Pro 3



- Power supply 110-240 V~
- Max load 16 A per channel, 48 A total
- Connectivity ZWLR  
EU: 864 MHz  
US: 912 MHz  
Z-Wave Plus  
EU: 868.4 MHz  
US: 908.4 MHz  
ANZ: 919.8 MHz
- CPU Z-Wave® S800
- Size (HxWxD) 96x53x59 mm / 3.78x2.01x2.32 inch
- Weight 150 g / 5.29 oz
- Certifications RED, LVD, EMC, CE, RCM, FCC, SA

more info →





GLOBAL



### Shelly Pro 4PM



Power supply 110-240 V~

Max load 16 A per channel, 40 A total

Connectivity Wi-Fi 4  
Bluetooth 4.2  
LAN

CPU ESP32-D0WDQ6

Flash Memory 8 MB

Size (HxWxD) 96x53x59 mm /  
3.78x2.01x2.32 inch

Weight 150 g / 5.29 oz

Certifications RED, LVD, EMC, CE, RCM



more info →

GLOBAL



### Shelly Pro Dual Cover/ Shutter PM



Power supply 110-240 V~

Max load 16 A per channel, 32 A total

Connectivity Wi-Fi 4  
Bluetooth 4.2  
LAN

CPU ESP32-D0WDQ6

Flash Memory 8 MB

Size (HxWxD) 96x53x59 mm /  
3.78x2.01x2.32 inch

Weight 150 g / 5.29 oz

Certifications RED, LVD, EMC, CE



more info →

TYPICALLY USED FOR



Energy monitoring



Energy saving



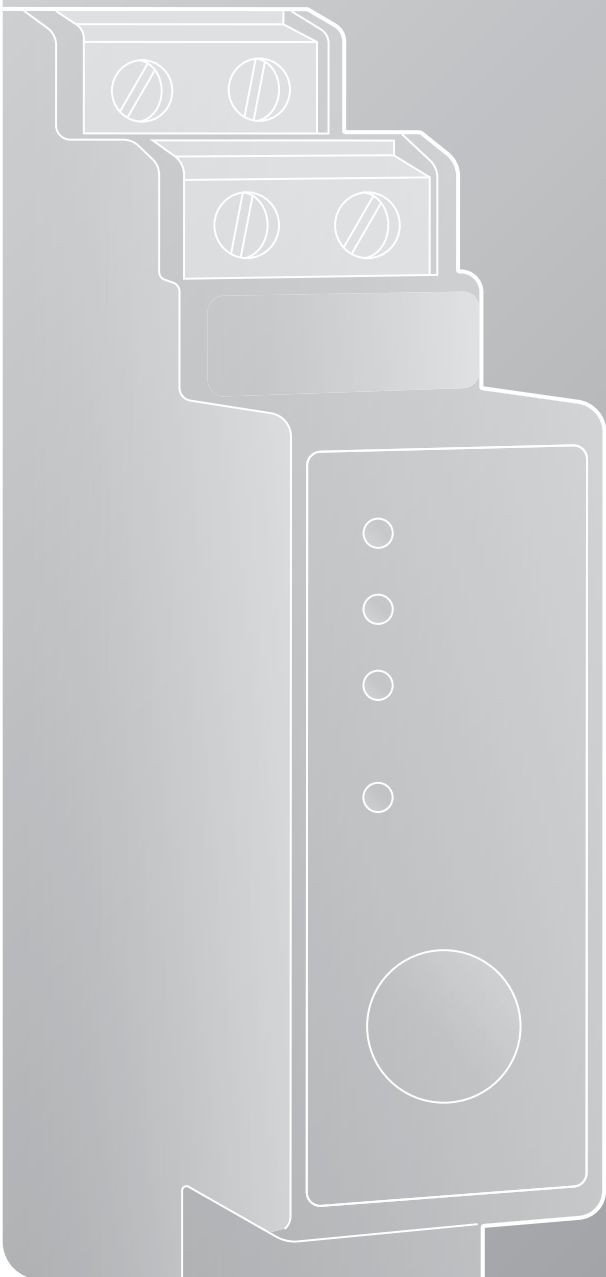
Electric chargers

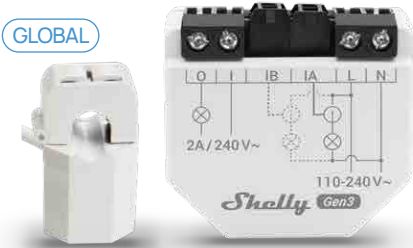


Photo voltaic



# Energy meters





**Shelly  
EM Gen3**



Power supply **110-240 V~**

Max load **2 A (240 V~)**

Internal data storage **Up to 10 days of 1 min data records**

Relay Inside **Yes**

Connectivity **Wi-Fi 4  
Bluetooth 4.2**

CPU **ESP-Shelly-C38F**

Flash Memory **8 MB**

Size (HxWxD) **37x42x16 mm /  
1.46x1.65x0.63 inch**

Weight **EM Gen3 - 23 g / 0.81 oz**

Certifications **RED, LVD, EMC, CE**

[more info →](#)



**Shelly  
3EM-63T Gen3**



Power supply **220-240 V~**

Ammeters **0 - 63 A (130 A saturation)**

Internal data storage **Up to 7 days**

Relay Inside **No**

Connectivity **Wi-Fi 4  
Bluetooth 4.2**

CPU **ESP-Shelly-C38F**

Flash Memory **8 MB**

Size (HxWxD) **31x54x42 mm /  
1.22x2.13x1.65 in**

Weight **52 g / 1.83 oz**

Certifications **RED, LVD, EMC, CE**

[more info →](#)



**Shelly  
3EM-63W Gen3**



Power supply **220-240 V~**

Ammeters **0 - 63 A (130 A saturation)**

Internal data storage **Up to 7 days**

Relay Inside **No**

Connectivity **Wi-Fi 4  
Bluetooth 4.2**

CPU **ESP-Shelly-C38F**

Flash Memory **8 MB**

Size (HxWxD) **21x54x42 mm /  
0.83x2.13x1.65 inch**

Weight **58 g / 2.05 oz**

Certifications **RED, LVD, EMC, CE**

[more info →](#)





GLOBAL



### Shelly PM Mini Gen3



Power supply 110-240 V~

Max load 16 A (240 V~)

Relay Inside No

Connectivity Wi-Fi 4  
Bluetooth 4.2

CPU ESP-Shelly-C38F

Flash Memory 8 MB

Size (HxWxD) 29x34x16 mm /  
1.34x1.11x0.63 inch

Weight 19 g / 0.65 oz

Certifications RED, LVD, EMC, CE

[more info →](#)

GLOBAL



### Shelly EM Mini Gen4



Power supply 110-240 V~

Max load 16 A (240 V~)

Relay Inside No

Connectivity Wi-Fi 6  
Bluetooth 5  
Zigbee 802.15.4

CPU ESP-Shelly-C68F

Flash Memory 8 MB

Size (HxWxD) 29x34x16 mm /  
1.34x1.11x0.63 inch

Weight 19 g / 0.65 oz

Certifications RED, LVD, EMC, CE

[more info →](#)

EU

US

ANZ



### Shelly Wave PM Mini



Power supply 110-240 V~

Max load 16 A (240 V~)

Relay Inside No

Connectivity ZWLR  
US: 912 MHz  
Z-Wave Plus  
EU: 868.4 MHz  
US: 908.4 MHz  
ANZ: 919.8 MHz

CPU Z-Wave® S800

Size (HxWxD) 29x34x16 mm /  
1.34x1.11x0.63 inch

Weight 19 g / 0.65 oz

Certifications RED, LVD, EMC, CE, FCC, SA

[more info →](#)



GLOBAL



### Shelly Pro EM-50



Power supply 100 - 260 V~

Ammeters 0 - 50 A  
(RMS via CT)

Relay Inside **Yes**

Connectivity **Wi-Fi 4**  
**Bluetooth 4.2**  
**LAN**

CPU **ESP32-D0WDQ6**

Flash Memory **16 MB**

Size (HxWxD) **94x19x69 mm /**  
**3.70x0.75x2.71 in**

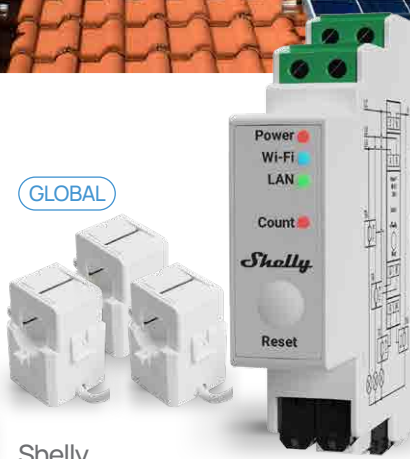
Weight **63 g / 2.22 oz**

Certifications **RED, LVD, EMC, CE,**  
**RCM**



[more info →](#)

GLOBAL



### Shelly Pro 3EM-120



Power supply 100 - 260 V~

Ammeters 0 - 120 A  
(RMS via CT)

Relay Inside **No**

Connectivity **Wi-Fi 4**  
**Bluetooth 4.2**  
**LAN**

CPU **ESP32-D0WDQ6**

Flash Memory **16 MB**

Size (HxWxD) **94x19x69 mm /**  
**3.70x0.75x2.71 in**

Weight **62 g / 2.19 oz**

Certifications **RED, LVD, EMC, CE,**  
**RCM**



[more info →](#)

GLOBAL



### Shelly Pro 3EM-400



Power supply 100 - 260 V~

Ammeters 0 - 400 A  
(RMS via CT)

Relay Inside **No**

Connectivity **Wi-Fi 4**  
**Bluetooth 4.2**  
**LAN**

CPU **ESP32-D0WDQ6**

Flash Memory **16 MB**

Size (HxWxD) **94x19x69 mm /**  
**3.70x0.75x2.71 in**

Weight **62 g / 2.19 oz**

Certifications **RED, LVD, EMC, CE,**  
**RCM**



[more info →](#)



GLOBAL

## Shelly Pro 3EM 3CT 63



Power supply	100 - 260 V~
Ammeters (RMS via CT)	0 - 63 A
Relay Inside	No
Connectivity	Wi-Fi 4 Bluetooth 4.2 LAN
CPU	ESP32-D0WDQ6
Flash Memory	16 MB
Size (HxWxD)	94x19x69 mm / 3.70x0.75x2.71 in
Weight	62 g / 2.19 oz
Certifications	RED, LVD, EMC, CE, RCM

[more info →](#)

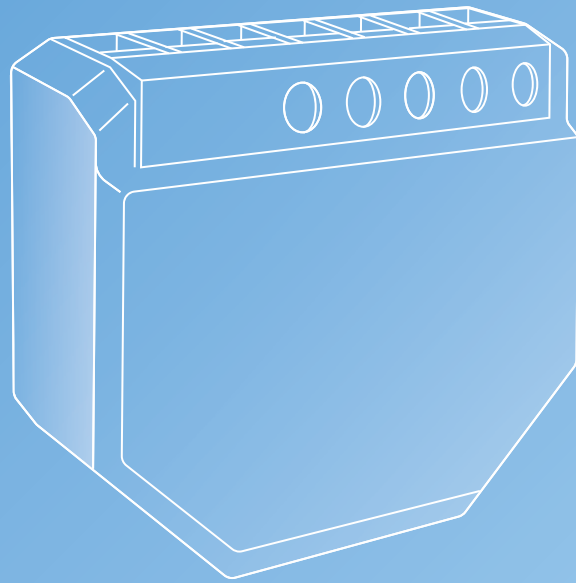
GLOBAL



## Shelly Pro 3EM Switch Add-on

Power supply	3.3V ~ and 12V ~ (from Shelly Pro 3EM device)
Ammeters	-
Relay Inside	Yes
Max switching voltage	240 V~/30 V ~
Max switching current	2 A
Flash Memory	-
Size (HxWxD)	94x19x69 mm / 3.70x0.75x2.71 in
Weight	20 g / 0.70 oz
Certifications	LVD, EMC, CE, RCM

[more info →](#)



# Lighting control for no neutral installations

TYPICALLY USED FOR



Lights



No neutral Instalation



Shelly  
**1L Gen3**



Power supply **220-240 V~ 50Hz (Shelly Bypass is required)**

Max. switching power **200W**

Connectivity **Wi-Fi 4  
Bluetooth 4.2**

CPU **ESP-Shelly-C38F**

Flash Memory **8 MB**

Size (HxWxD) **37x42x16 mm /  
1.46x1.65x0.63 inch**

Weight **24 g / 0.85 oz**

Certifications **RED, LVD, EMC, CE**



[more info →](#)



Shelly  
**2L Gen3**



Power supply **220-240 V~ 50Hz (Shelly Bypass is required)**

Max. switching power **200W through O1  
700W through O2**

Connectivity **Wi-Fi 4  
Bluetooth 4.2**

CPU **ESP-Shelly-C38F**

Flash Memory **8 MB**

Size (HxWxD) **37x42x16 mm /  
1.46x1.65x0.63 inch**

Weight **24 g / 0.85 oz**

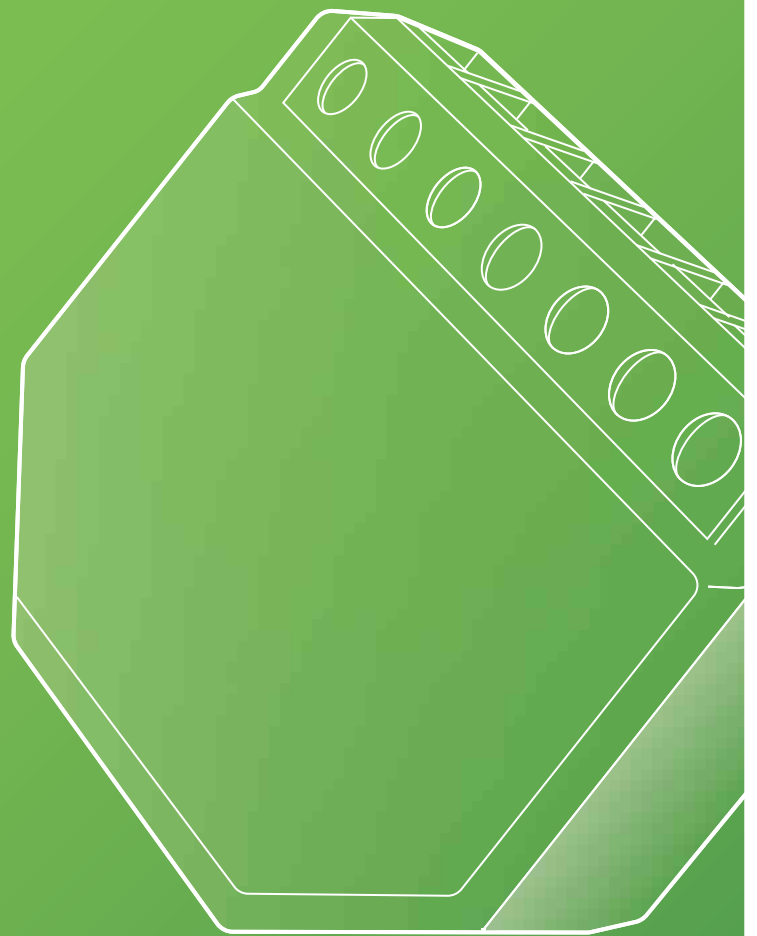
Certifications **RED, LVD, EMC, CE**



[more info →](#)



# Dimmers



TYPICALLY USED FOR



LED strips



Lights



Dimming



GLOBAL



### Shelly DALI Dimmer Gen3



Power supply	110-240 V~
Max load	Bus power supply guaranteed 10mA (up to 5 DALI control gear units), Short circuit current < 35 mA
Connectivity	Wi-Fi 4 Bluetooth 4.2
CPU	ESP32-C3 Shelly
Flash Memory	8 MB
Size (HxWxD)	38x42.5x16.5 mm / 1.50x1.67x0.65 inch
Weight	18 g / 0.63 oz
Certifications	RED, LVD, EMC, CE, RCM, DALI-2



[more info →](#)

EU  
ANZ



### Shelly Dimmer Gen3



Compatible with no neutral installation

Power supply	220-240 V~, 50 Hz (Shelly Bypass is required)
Ammeter range (AC)	0 A - 3 A, ± 5 % (when used with neutral)
Dimming type	Trailing edge
Connectivity	Wi-Fi 4 Bluetooth 4.2
CPU	ESP32 C3 / STM32 G051
Flash Memory	8 MB
Size (HxWxD)	38x42.5x16.5 mm / 1.50x1.67x0.65 inch
Weight	24.3 g / 0.86 oz
Certifications	RED, LVD, EMC, CE, RCM



[more info →](#)

EU



### Shelly Dimmer Gen4



Compatible with no neutral installation

Power supply	220-240 V~, 50 Hz (Shelly Bypass is required)
Ammeter range (AC)	0 A - 3 A, ± 5 % (when used with neutral)
Dimming type	Trailing edge
Connectivity	Wi-Fi 6 Bluetooth 5 Zigbee 802.15.4
CPU	ESP-Shelly-C68F STM32 G051
Flash Memory	8 MB
Size (HxWxD)	38.5x43.5x17mm / 1.52x1.71x0.67in
Weight	24.3 g / 0.86 oz
Certifications	RED, LVD, EMC, CE, SAA



[more info →](#)



EU  
US  
ANZ



### Shelly Wave Dimmer



Power supply **220-240 V ~, 50 Hz**

Max load **200 W**

Connectivity **ZWLR**  
 EU: 864 MHz  
 Z-Wave Plus  
 EU: 868.4 MHz  
 US: 908.4 MHz  
 ANZ: 919.8 MHz

CPU **Z-Wave® S800**

Size (HxWxD) **37x42x16 ±0.5 mm / 1.46x1.65x0.63 ±0.02 in**

Weight **25 g / 0.88 oz.**

Certifications **RED, LVD, EMC, CE, RCM, FCC, SA**



[more info →](#)

GLOBAL



### Shelly Pro Dimmer 1PM



Power supply **110-240 V~**

Max load **200 W**

Connectivity **Wi-Fi 4**  
 Bluetooth 4.2  
 LAN  
 CPU **ESP32-D0WWDQ6**

Flash Memory **8 MB**

Size (HxWxD) **94x19x69 mm / 3.70x0.75x2.71 in**

Weight **75 g / 2.7 oz**

Certifications **LVD, RED, EMC, CE, RCM**



[more info →](#)

EU  
US  
ANZ



### Shelly Wave PRO Dimmer 1PM



Power supply **110-240 V~**

Max load **200 W**

Connectivity **Z-Wave Plus**  
 EU: 868.4 MHz  
 US: 908.4 MHz  
 ANZ: 919.8 MHz

CPU **Z-Wave® S800**

Flash Memory **512 kB**

Size (HxWxD) **94x19x69 mm / 3.70x0.75x2.71 in**

Weight **75 g / 2.7 oz**

Certifications **LVD, RED, EMC, CE, FCC, SA**



[more info →](#)



GLOBAL

### Shelly Pro Dimmer 2PM



- Power supply 110-240 V~
- Max load 200 W per channel
- Connectivity Wi-Fi 4  
Bluetooth 4.2  
LAN
- CPU ESP32-D0WDQ6
- Flash Memory 8 MB
- Size (HxWxD) 94x19x69 mm / 3.70x0.75x2.71 in
- Weight 75 g / 2.7 oz
- Certifications LVD, RED, EMC, CE, RCM



[more info →](#)



EU  
US  
ANZ

### Shelly Wave PRO Dimmer 2PM



- Power supply 110-240 V~
- Max load 200 W per channel
- Connectivity Z-Wave Plus  
EU: 868.4 MHz  
US: 908.4 MHz  
ANZ: 919.8 MHz  
Z-Wave® S800
- CPU
- Flash Memory 512 kB
- Size (HxWxD) 94x19x69 mm / 3.70x0.75x2.71 in
- Weight 75 g / 2.7 oz
- Certifications RED, LVD, EMC, CE, RCM, FCC, SA



[more info →](#)



US

### Shelly Plus Wall Dimmer



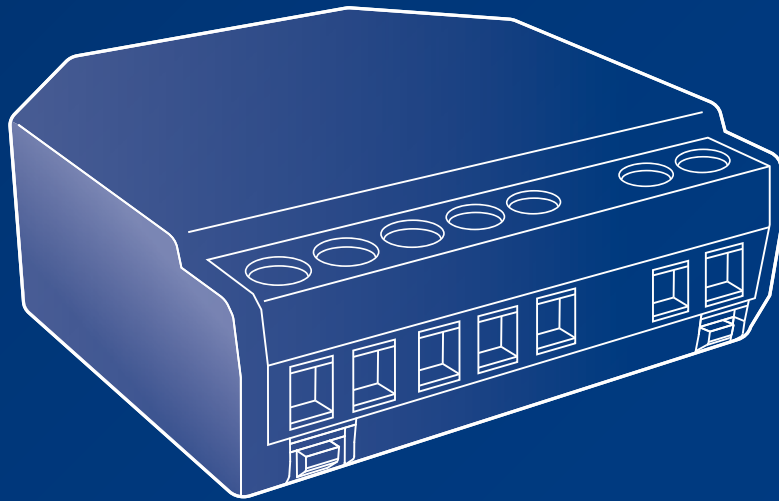
- Power supply 100 - 120 V
- Max load 400 W (incandescent)  
150 W (dimming only LED and CFL)
- Connectivity Wi-Fi 4  
Bluetooth 4.2
- CPU ESP32
- Flash Memory 4 MB
- Size (HxWxD) 120x70x39 mm / 4.72 x 2.76 x 1.50 in
- Weight 121 g / 4.28 oz
- Certifications LVD, RED, EMC, CE



[more info →](#)



# 0/1-10V Controllers



TYPICALLY USED FOR



LED strips



Lights



Dimming



Power monitoring



GLOBAL



Shelly  
**Dimmer 0/1-10V PM  
Gen3**



Power supply **110-240 V~**

Max load **13 A (240 V~)**

Connectivity **Wi-Fi 4  
Bluetooth 4.2**

CPU **Shelly ESP32 C3**

Flash Memory **8 MB**

Size (HxWxD) **38.5x43.5x17mm /  
1.52x1.71x0.67in**

Weight **28.5 g / 0.99 oz**

Certifications **RED, LVD, EMC, CE, RCM**



[more info →](#)

GLOBAL



Shelly  
**Pro Dimmer 0/1-10V PM**



Power supply **110-240 V~**

Max load **16 A (240 V~)**

Connectivity **Wi-Fi 4  
Bluetooth 4.2  
LAN**

CPU **ESP32-D0WDQ6**

Flash Memory **8 MB**

Size (HxWxD) **94x19x69 mm /  
3.70x0.75x2.71 in**

Weight **70 g / 2.5 oz**

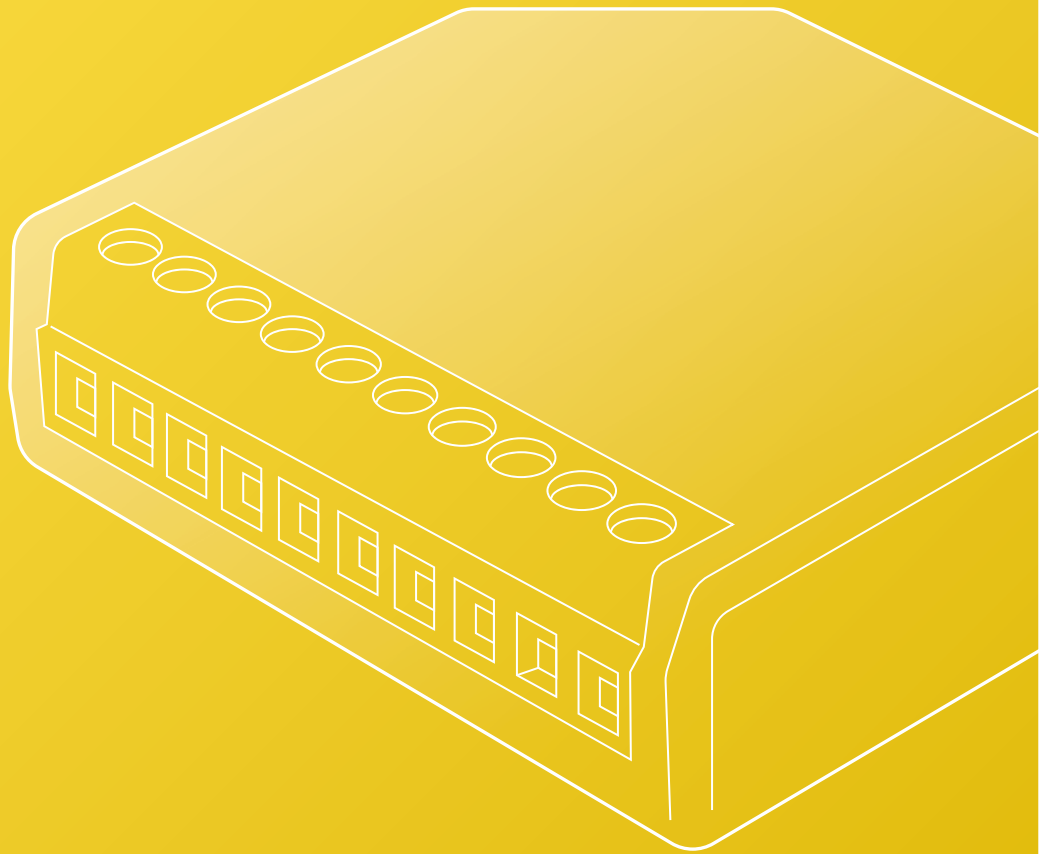
Certifications **RED, LVD, EMC, CE, RCM**



[more info →](#)



# RGBW / RGBWW Controllers



TYPICALLY USED FOR



LED strips



Lights



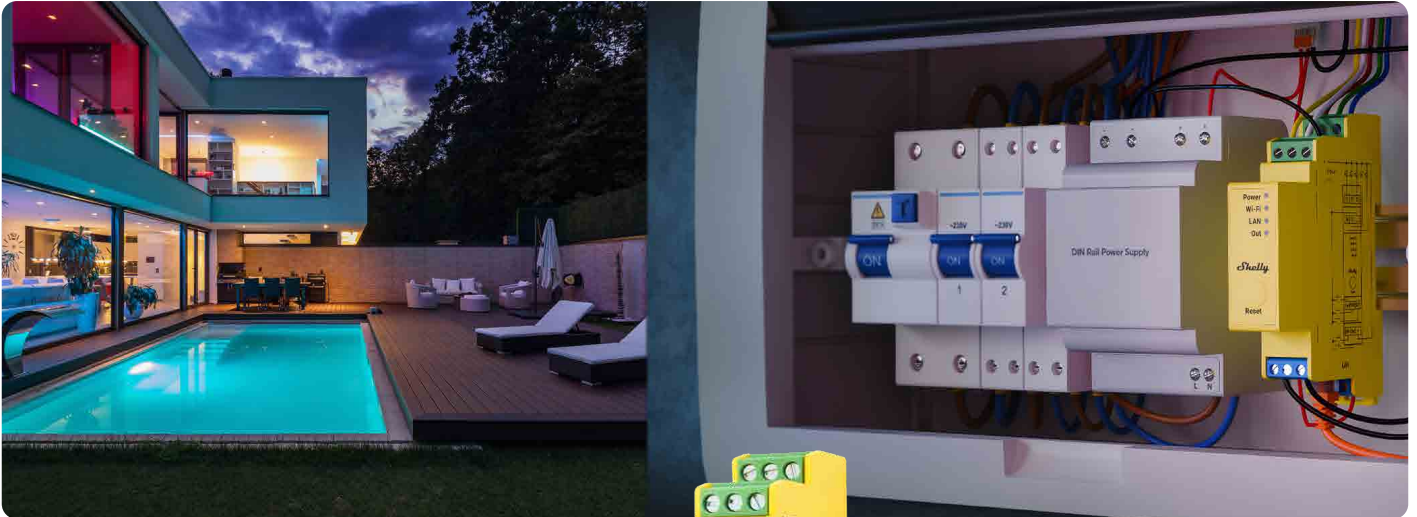
Dimming



Colour



Power monitoring



GLOBAL



Shelly  
**Plus RGBW PM**



Power supply 12-24 V $\overline{\text{=}}$

Max load 4 A per channel (10 A total)

Connectivity **Wi-Fi 4**  
**Bluetooth 4.2**

CPU ESP-Shelly-C38F

Flash Memory 4 MB

Size (HxWxD) 42x37x12 mm /  
1.65x1.46x0.66 inch

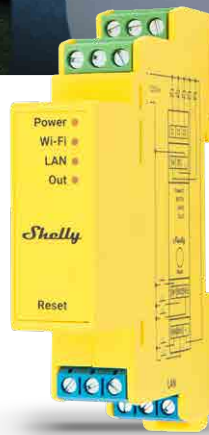
Weight 17 g / 0.60 oz

Certifications RED, EMC, CE, RCM



more info →

GLOBAL



Shelly  
**PRO RGBWW PM**



Power supply 12-24 V $\overline{\text{=}}$

Max load 6 A per channel (16 A total)

Connectivity **Wi-Fi 4**  
**Bluetooth 4.2**  
**LAN**

CPU ESP32-D0WDQ6

Flash Memory 8 MB

Size (HxWxD) 94x19x69 mm /  
3.70x0.75x2.71 inch

Weight 61 g / 2.15 oz

Certifications RED, EMC, CE



more info →

TYPICALLY USED FOR



Lights



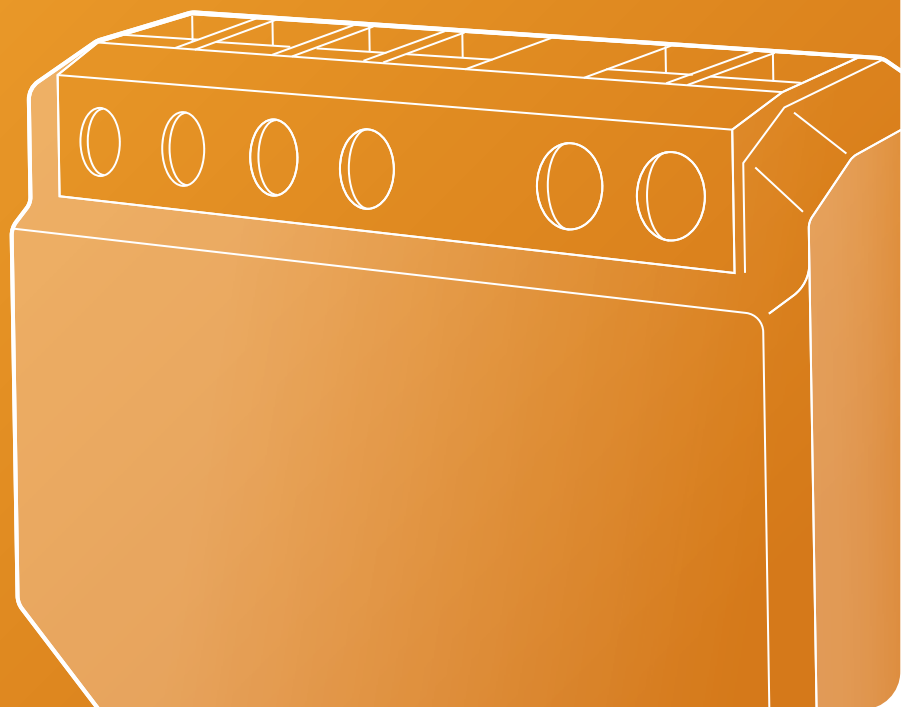
Appliances



Scene activation



# Input Controllers





Shelly  
**Plus i4**



Power supply **110-240 V~**

Max load -

Connectivity **Wi-Fi 4**  
**Bluetooth 4.2**

CPU **ESP32-U4WDH**

Flash Memory **4 MB**

Size (HxWxD) **37x42x16 mm /**  
**1.46x1.65x0.63 in**

Weight **18 g / 0.63 oz**

Certifications **LVD, RED, EMC, CE, RCM**

[more info →](#)



Shelly  
**i4 Gen3**



Power supply **110-240 V~**

Max load -

Connectivity **Wi-Fi 4**  
**Bluetooth 4.2**

CPU **ESP-Shelly-C38F**

Flash Memory **8 MB**

Size (HxWxD) **37x42x16 mm /**  
**1.46x1.65x0.63 in**

Weight **19 g / 0.67 oz**

Certifications **LVD, RED, EMC, CE, RCM**

[more info →](#)



Shelly  
**Wave i4**



Power supply **110-240 V~**

Max load -

Connectivity **ZWLR**  
**EU: 864 MHz**  
**US: 912 MHz**  
**Z-Wave Plus**  
**EU: 868.4 MHz**  
**US: 908.4 MHz**  
**ANZ: 919.8 MHz**  
**Z-Wave® S800**

CPU

Size (HxWxD) **37x42x16 mm /**  
**1.46x1.65x0.63 in**

Weight **17 g / 0.6 oz**

Certifications **RED, LVD, EMC, CE, FCC, SA**

[more info →](#)





GLOBAL



### Shelly Plus i4 DC



Power supply 5-24 V $\overline{\text{DC}}$

Max load -

Connectivity **Wi-Fi 4**  
**Bluetooth 4.2**

CPU ESP32-U4WDH

Flash Memory 4 MB

Size (HxWxD) 37x42x16 mm /  
1.46x1.65x0.63 in

Weight 17 g / 0.6 oz

Certifications LVD, RED, EMC, CE



[more info →](#)

EU

US

ANZ



### Shelly Wave i4 DC



Power supply 5-24 V $\overline{\text{DC}}$

Max load -

Connectivity **ZWLR**  
**US: 912 MHz**  
**Z-Wave Plus**  
**EU: 868.4 MHz**  
**US: 908.4 MHz**  
**ANZ: 919.8 MHz**  
**Z-Wave<sup>®</sup> S800**

CPU

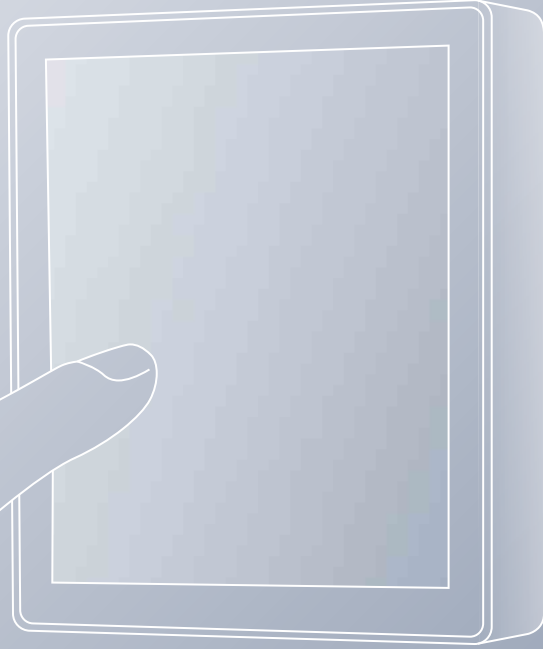
Size (HxWxD) 37x42x16 mm /  
1.46x1.65x0.63 in

Weight 17 g / 0.6 oz

Certifications LVD, RED, EMC, CE, FCC, SA



[more info →](#)



# Control Panels

TYPICALLY USED FOR



Room management



Centralized control



Thermostat



EU

ANZ



Shelly  
**Wall Display**



Power supply **230 V~**

Max load **5 A**

Connectivity **Wi-Fi 4  
Bluetooth 4.2**

CPU **MTK6580**

Flash Memory **4 GB**

Size (HxWxD) **85x85x30 mm /  
3.35x3.35x1.18 inch**

Weight **180 g / 6.35 oz**

Display **4 inch color display**

Certifications **RED, LVD, EMC, CE, RCM**



[more info →](#)

EU



Shelly  
**Wall Display X2i**



Power supply **100-240 V~ / USB Type-C  
power supply 5 V==**

Max load **5 A**

Connectivity **Wi-Fi 6 Dual Band  
(2.4 GHz & 5 GHz)  
Bluetooth 5.0**

CPU **Rockchip RK3326,  
Cortex-A53**

Flash Memory **4 GB**

Size (HxWxD) **87x178x36 mm /  
3.43x7x1.42 inch**

Weight **292 g / 10.3 oz**

Display **6.95 inch color display**

Certifications **RED, LVD, EMC, CE**



[more info →](#)

EU



Shelly  
**Wall Display XL**



Power supply **100 - 240 V~ 50/60Hz /  
USB Type-C power supply  
5 V== / 3 A**

Max load **5 A**

Connectivity **Wi-Fi 6 Dual Band  
(2,4 GHz & 5 GHz)  
Bluetooth 5.4**

CPU **Rockchip RK3566 Quad  
core Cortex-A9**

Flash Memory **16 GB**

Size (HxWxD) **155,8x272,5x38,3 mm /  
6.13x10.7x1.50 inch**

Weight **920 g / 32.45 oz**

Display **10.1 inch 5-point capacity  
color display**

Certifications **RED, LVD, EMC, CE**



[more info →](#)



# Plug&Play



TYPICALLY USED FOR



Appliances



Heating & Cooling



Lights



Energy saving



Power monitoring



EU



Shelly  
**Plug S MTR Gen3**



Power supply **220 - 230 V~**  
 Max load **12 A**  
 Socket type **Type F / Schuko**  
 Connectivity **Wi-Fi 4**  
**Bluetooth 4.2**  
 CPU **ESP-Shelly-C38F**  
 Flash Memory **8 MB**  
 Size (HxWxD) **44x44x70 mm /**  
**1.73x1.73x2.75 in**  
 Weight **60 g / 2.08 oz**  
 Certifications **LVD, RED, EMC, CE**



[more info →](#)



EU



Shelly  
**Wave Plug S**



Power supply **220 - 230 V~**  
 Max load **12 A**  
 Socket type **Type F / Schuko**  
 Connectivity **ZWLR**  
**EU: 864 MHz**  
**Z-Wave Plus**  
**EU: 868.4 MHz**  
**Z-Wave® S800**  
 CPU  
 Flash Memory **512 kB**  
 Size (HxWxD) **44x44x70 mm /**  
**1.73x1.73x2.75 in**  
 Weight **60 g / 2.08 oz**  
 Certifications **LVD, RED, EMC, CE**



[more info →](#)



EU



Shelly  
**Plug PM Gen3**



No relay inside

Power supply **230 V~**  
 Max load **16 A**  
 Socket type **Type F / Schuko**  
 Connectivity **Wi-Fi 4**  
**Bluetooth 4.2**  
 CPU **ESP-Shelly-C38F**  
 Flash Memory **8 MB**  
 Size (HxWxD) **44x44x70 mm /**  
**1.73x1.73x2.75 in**  
 Weight **60 g / 2.08 oz**  
 Certifications **LVD, RED, EMC, CE**



[more info →](#)



Shelly  
**Plug M Gen3**



Power supply **230 V~ 50 Hz**

Max load **13 A**

Socket type **Type F / Schuko**

Connectivity **Wi-Fi 4**  
**Bluetooth 4.2**

CPU **ESP-Shelly-C38F**

Flash Memory **8 MB**

Size (HxWxD) **46 x 46 x 85 mm /**  
**1.81 x 1.81 x 3.35 in**

Weight **73 g / 2.57 oz**

Certifications **LVD, RED, EMC, CE**

more info →



Shelly  
**Plus Plug UK**



Power supply **230 V~**

Max load **13 A**

Socket type **Type G / BS 1363**

Connectivity **Wi-Fi 4**  
**Bluetooth 4.2**

CPU **ESP32-U4WDH**

Flash Memory **4 MB**

Size (HxWxD) **60x60x56 mm /**  
**2.36x2.36x2.20 in**

Weight **74 g / 2.6 oz**

Certifications **LVD, RED**

more info →



Shelly  
**Wave Plug UK**



Power supply **230 V~**

Max load **13 A**

Socket type **Type G / BS 1363**

Connectivity **ZWLR**  
**EU: 864 MHz**  
**Z-Wave Plus**  
**EU: 868.4 MHz**  
**Z-Wave® S800**

CPU

Flash Memory **512 kB**

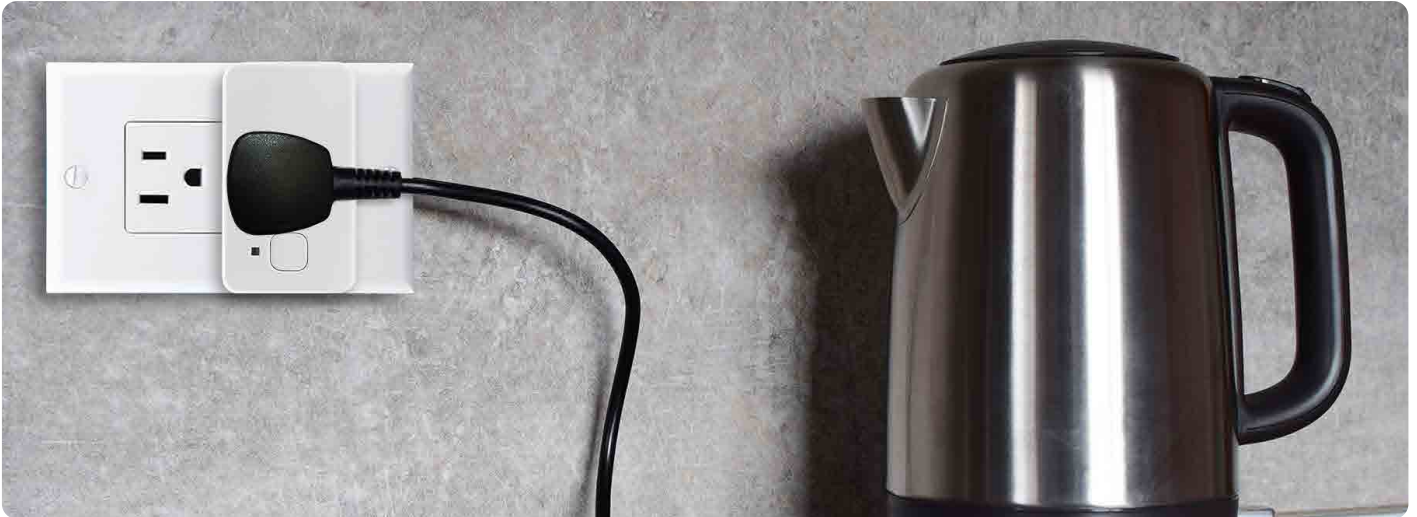
Size (HxWxD) **60x60x56 mm /**  
**2.36x2.36x2.20 in**

Weight **74 g / 2.6 oz**

Certifications **LVD, RED, EMC, CE**

more info →





US



### Shelly Plus Plug US



Power supply **120 V~**  
 Max load **15 A**  
 Socket type **Type B / NEMA 5-15**  
 Connectivity **Wi-Fi 4**  
**Bluetooth 4.2**  
 CPU **ESP32**  
 Flash Memory **4 MB**  
 Size (HxWxD) **38x84x52 mm / 1.5x3.3x2.0 in**  
 Weight **70 g / 2.47 oz**  
 Certifications **FCC, ETL**



[more info →](#)

US



### Shelly Wave Plug US



Power supply **120 V~**  
 Max load **15 A**  
 Socket type **Type B / NEMA 5-15**  
 Connectivity **ZWLR**  
**US: 912 MHz**  
**Z-Wave Plus**  
**US: 908,4 MHz**  
**Z-Wave® S800**  
 CPU  
 Flash Memory **512 kB**  
 Size (HxWxD) **38x84x52 mm / 1.5x3.3x2.0 in**  
 Weight **70 g / 2.47 oz**  
 Certifications **FCC, ETL**



[more info →](#)

US



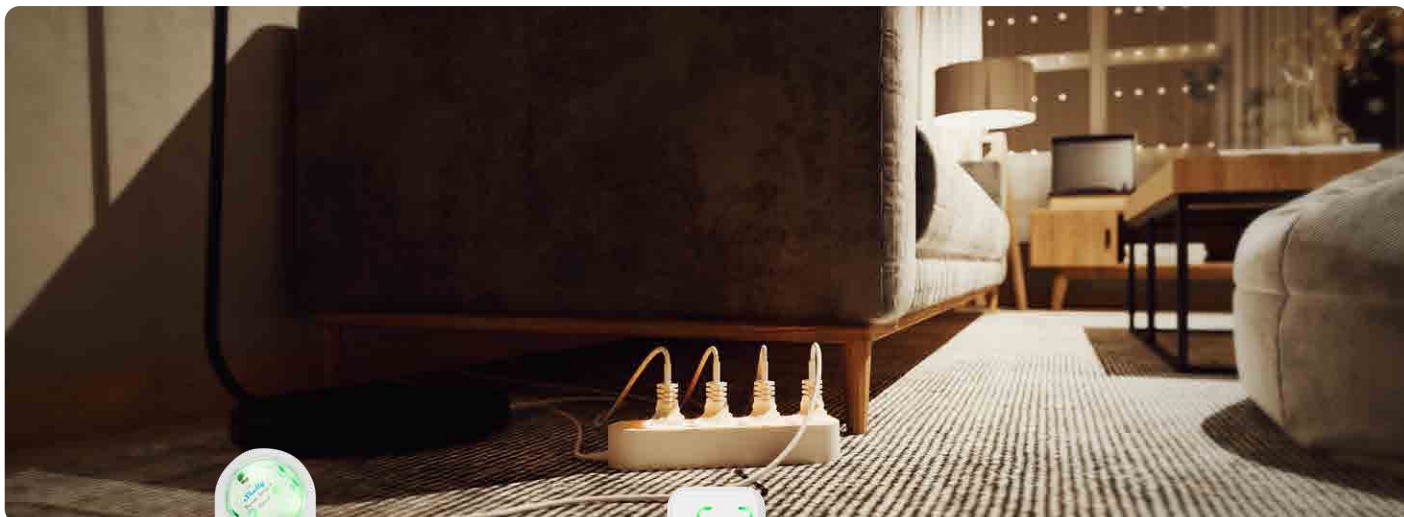
### Shelly Plug US Gen4



Power supply **120 V~**  
 Max load **15 A**  
 Socket type **Type B / NEMA 5-15**  
 Connectivity **Wi-Fi 6**  
**Bluetooth 5**  
**Zigbee 802.15.4**  
 CPU **ESP-Shelly-C68F**  
 Flash Memory **8 MB**  
 Size (HxWxD) **38x64x51 mm / 1.50x2.52x2.01 inch**  
 Weight **64 g / 2.25 oz**  
 Certifications **FCC, UL**



[more info →](#)



EU



Shelly  
**Power Strip 4 Gen4**



Power supply 220 - 240 V~ 50/60 Hz  
 Max load 16 A total /  
 12 A per individual socket  
 Socket type Type F / Schuko  
 Connectivity Wi-Fi 6  
 Bluetooth 5  
 Zigbee 802.15.4  
 CPU ESP-Shelly-C68F  
 Flash Memory 8 MB  
 Size (HxWxD) 43x237x56 mm /  
 1.69x9.33x2.20 inch  
 Weight 560 g / 19.75 oz  
 Certifications RED, LVD, EMC, CE



more info →

US



Shelly  
**Power Strip 4 Gen4 US**



Power supply 120 V~, 60 Hz  
 Max load 15 A total /  
 15 A per individual socket  
 Socket type NEMA 5-15 (Type-B)  
 Connectivity Wi-Fi 6  
 Bluetooth 5  
 Zigbee 802.15.4  
 CPU ESP-Shelly-C68F  
 Flash Memory 8 MB  
 Size (HxWxD) 31x208x57 mm /  
 1.22x8.19x2.24 inch  
 Weight 482 g / 17 oz  
 Certifications FCC, RED, LVD, EMC



more info →



Shelly  
**Outdoor Plug S Gen3**



Power supply **230 V~**  
 Max load **12 A**  
 Socket type **Type F / Schuko**  
 Connectivity **Wi-Fi 4**  
**Bluetooth 4.2**  
 CPU **ESP-Shelly-C38F**  
 Flash Memory **8 MB**  
 Size (HxWxD) **56x56x103 mm /**  
**2.21x2.21x4.55 in**  
 Weight **85 g / 3 oz**  
 Certifications **RED, LVD, EMC, CE**



[more info →](#)



Shelly  
**Wave Outdoor Plug S**



Power supply **230 V~**  
 Max load **12 A**  
 Socket type **Type F / Schuko**  
 Connectivity **ZWLR**  
**EU: 864 MHz**  
**Z-Wave Plus**  
**EU: 868.4 MHz**  
**Z-Wave® S800**  
 CPU  
 Flash Memory **512 kB**  
 Size (HxWxD) **56x56x103 mm /**  
**2.21x2.21x4.55 in**  
 Weight **85 g / 3 oz**  
 Certifications **RED, LVD, EMC, CE**



[more info →](#)



EU



Shelly  
**DUO E27/GU10**



	E27	GU10
Power supply	100-240 V~	
Power rating	9W	5W
Socket type	E27	GU10
Connectivity	Wi-Fi 4	Wi-Fi 4
Beam angle	180°	120°
Color temperature	2700 K - 6500 K	
Brightness	Up to 800 lm	Up to 400 lm
Lifetime	30000 hours	
Size (WxH)	60x122 mm / 50x73 mm / 2.36x4.08 in 1.96x2.87 in	
Certifications	RED, LVD, EMC, CE	



more info →

EU



Shelly  
**DUO RGBW E27/GU10**



	E27	GU10
Power supply	100-240 V~	
Power rating	9W	5W
Socket type	E27	GU10
Connectivity	Wi-Fi 4	Wi-Fi 4
Beam angle	180°	120°
Color temperature	RGB + Natural white (4000 K)	
Brightness	Up to 800 lm	Up to 400 lm
Lifetime	30000 hours	
Size (WxH)	60x122 mm / 50x73 mm / 2.36x4.08 in 1.96x2.87 in	
Certifications	RED, LVD, EMC, CE	



more info →



EU



Shelly  
**Vintage A60**



Power supply **230 V~**  
 Power rating **7 W**  
 Socket type **E27**  
 Connectivity **Wi-Fi 4**  
 Beam angle **360°**  
 Color temperature **2700 K (Warm white)**  
 Brightness **750 Lm**  
 Lifetime **15000 hours**  
 Size (WxH) **60x117 mm / 2.36x4.52 in**  
 Certifications **RED, LVD, EMC, CE**



more info →

EU



Shelly  
**Vintage ST64**



Power supply **230 V~**  
 Power rating **7 W**  
 Socket type **E27**  
 Connectivity **Wi-Fi 4**  
 Beam angle **360°**  
 Color temperature **2700 K (Warm white)**  
 Brightness **750 Lm**  
 Lifetime **15000 hours**  
 Size (WxH) **64x160 mm / 2.51x6.29 in**  
 Certifications **RED, LVD, EMC, CE**



more info →

EU



Shelly  
**Vintage G125**



Power supply **230 V~**  
 Power rating **4 W**  
 Socket type **E27**  
 Connectivity **Wi-Fi 4**  
 Beam angle **360°**  
 Color temperature **2700 K (Warm white)**  
 Brightness **260 Lm**  
 Lifetime **15000 hours**  
 Size (WxH) **125x155 mm / 4.92x6.10 in**  
 Certifications **RED, LVD, EMC, CE**



more info →



# Sensors & Remote Control

TYPICALLY USED FOR



Room management



Heating & Cooling



Motion detection



Leak & Gas detection

## SENSORS & REMOTE CONTROL



Shelly  
**BLU TRV**



Power supply	2x AA, 1.5 V batteries
Battery life	Up to 2 years (depending on usage)
Mounting	M30x1.5 6 adapters included
Connectivity	Bluetooth 4.2
Size (HxD):	78 x Ø54 mm / 3.07xØ2.13 in
Weight	107 g / 3.77 oz
Certifications	LVD, RED, EMC, CE



[more info →](#)



Shelly  
**BLU H&T Display ZB**



Power supply	2 x CR2032, 3 V batteries
Battery life	Approx. 2 years (depending on usage)
Mounting	Stand alone Wall mounting
Connectivity	Bluetooth 5.0 Zigbee 802.15.4
Size (HxWxD)	65x65x9 mm / 2.56x2.56x0.35 inch (without stand)
Weight	43 g / 1.52 oz (with batteries and tabletop stand)
Certifications	LVD, RED, EMC, CE



[more info →](#)



Shelly  
**H&T Gen3**



Power supply	4x AA, 1.5 V batteries
Battery life	Up to 1 year (depending on usage)
Mounting	Stand alone Wall mounting
Connectivity	W-Fi 4 Bluetooth 4.2
Size (HxWxD)	70x70x26 mm / 2.76x2.76x1.02 inch (without stand)
Weight	47 g / 1.66 oz
Certifications	LVD, RED, EMC, CE



[more info →](#)

## SENSORS & REMOTE CONTROL



GLOBAL



### Shelly BLU H&T ZB



Power supply **1x 3 V CR2032 battery**

Battery life **Up to 3 years**

Mounting **On a flat surface**

Connectivity **Bluetooth 5.0  
Zigbee 802.15.4**

Size (HxWxD) **37x37x10 mm /  
1.46x1.46x0.39 in**

Weight **13 g / 0.44 oz**

Certifications **LVD, RED, EMC, CE**

[more info →](#)



EU

US

ANZ



### Shelly Wave H&T



Power supply **1x 3 V CR123A battery**

Battery life **Up to 2 years**

Mounting **On a flat surface**

Connectivity **Z-Wave Plus LR  
EU: 864 MHz  
US: 912 MHz**

**Z-Wave Plus  
EU: 868.4 MHz  
US: 908.4 MHz  
ANZ: 919.8 MHz**

Size (HxWxD) **35x46 mm / 1.38x1.81 in**

Weight **16 g without battery  
33 g with battery**

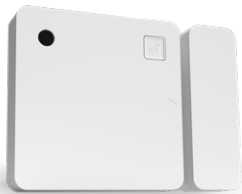
Certifications **LVD, RED, EMC, CE, FCC, SA**

[more info →](#)





GLOBAL



Shelly  
**BLU Door/Window**



- Power supply 1x 3 V CR2032 battery
- Battery life Up to 5 years
- Mounting Glued to door or window
- Connectivity Bluetooth 4.2
- Size (HxWxD) 35x35x7 mm/1.38x1.38x0.27 in (Sensor unit)  
35x12x7 / 1.44x0.47x0.27 in (Magnet)
- Weight 10 g / 0.35 oz -Device  
8 g / 0.28 oz - Magnet
- Certifications LVD, RED, EMC, CE

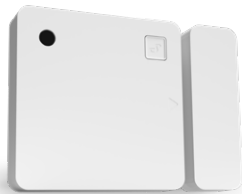


more info →

EU

US

ANZ



Shelly  
**Wave Door/Window**



- Power supply 1x 3 V CR2032 battery
- Battery life Up to 2 years
- Mounting Glued to door or window
- Connectivity **Z-Wave Plus LR**  
EU: 864 MHz  
US: 912 MHz  
  
**Z-Wave Plus**  
EU: 868.4 MHz  
US: 908.4 MHz  
ANZ: 919.8 MHz
- Size (HxWxD) 35x35x7 mm/1.38x1.38x0.27 in (Sensor unit)  
35x12x7 / 1.44x0.47x0.27 in (Magnet)
- Weight 10 g / 0.35 oz -Device  
8 g / 0.28 oz - Magnet
- Certifications LVD, RED, EMC, CE, FCC, SA



more info →

## SENSORS & REMOTE CONTROL



GLOBAL



### Shelly BLU Motion



Power supply 1x 3 V CR2477 battery

Battery life Up to 5 years

Mounting Glued

Connectivity Bluetooth 4.2

Size (HxWxD) 32x42x27 mm /  
1.26x1.65x1.06 in

Weight 26 g / 0.92 oz (Device with  
the battery)

Certifications LVD, RED, EMC, CE



[more info →](#)

EU

US

ANZ



### Shelly Wave Motion



Power supply 1x 3 V CR2477 battery

Battery life Up to 3 years

Mounting Glued

Connectivity **Z-Wave Plus LR**  
EU: 864 MHz  
US: 912 MHz

**Z-Wave Plus**  
EU: 868.4 MHz  
US: 908.4 MHz  
ANZ: 919.8 MHz

Size (HxWxD) 32x42x27 ±0.5 mm /  
1.26x1.65x1.06 ±0.02 in)

Weight 26 ±1 g / 0.92 ±0.05 oz  
(with the battery)

Certifications LVD, RED, EMC, CE, FCC, SA



[more info →](#)

GLOBAL



### Shelly GAS



Power supply 110-230 V~

Alarm indicator LED Flash & Sound

Connectivity W-Fi 4

Size (HxWxD) 89,5x89,5x38 mm /  
3.52x3.52x1.49 in

Certifications LVD, RED, EMC, CE



[more info →](#)



GLOBAL



Shelly  
**Flood**



Power supply **1 x CR123A – 3V batteries**

Battery life **Up to 18 months**

Mounting **Stand-alone**

Connectivity **W-Fi 4**

Size (HxWxD) **70x70x19 mm /  
2.75x2.75x0.74 in**

Certifications **LVD, RED, EMC, CE**



more info →

GLOBAL



Shelly  
**Flood Gen4**



Power supply **4 x AA - 1.5 V batteries**

Battery life **Up to 2 years**

Leak sensor cable **2 m,  
extendable up to 150 m**

Connectivity **Wi-Fi 6  
Bluetooth 5  
Zigbee 802.15.4**

CPU **ESP-Shelly-C68F**

Flash Memory **8 MB**

Size (HxWxD) **97x76x25 mm /  
3.82x2.99x0.98 inch**

Weight **91 g / 3.21 oz (without  
batteries)  
185 g / 6.53 oz (with  
batteries)**

Certifications **LVD, RED, EMC, CE**



more info →

GLOBAL



Shelly  
**Plus Smoke**



Power supply **1 x CR123A – 3V batteries**

Battery life **Up to 3 years**

Connectivity **W-Fi 4  
Bluetooth 4.2**

Size (HxWxD) **86x86x31mm /  
3.39x3.39x1.22 in**

Certifications **LVD, RED, EMC, CE**



more info →



EU



Shelly  
**BLU RC Button 4 ZB**



Power supply 1 x CR2032 – 3V batteries

Battery life Up to 2 years

Connectivity Bluetooth 5.0  
Zigbee 802.15.4

Size (HxWxD) Button: 65x30x13 mm /  
2.56x1.18x0.51 in  
Magnetic holder (for flat  
surfaces): 83x44x9 mm /  
3.27x1.73x0.35 in

Weight 21 g / 0.74 oz

Certifications LVD, RED, EMC, CE



[more info →](#)

US



Shelly  
**BLU RC Button 4 US ZB**



Power supply 1 x CR2032 – 3V batteries

Battery life Up to 2 years

Connectivity Bluetooth 5.0  
Zigbee 802.15.4

Size (HxWxD) Button: 65x30x13 mm /  
2.56x1.18x0.51 in  
Magnetic holder (for wall  
switch boxes): 105x44x13  
mm / 4.13x1.73x0.51 in

Weight 21 g / 0.74 oz

Certifications LVD, RED, EMC, CE



[more info →](#)

GLOBAL



Shelly  
**BLU Button Tough 1 ZB**



Power supply 1 x CR2032 – 3V batteries

Battery life Up to 2 years

Connectivity Bluetooth 5.0  
Zigbee 802.15.4

Size (HxWxD) 42x42x13 mm /  
1.65x1.65x0.51 in

Weight 15 g / 0.53 oz

Certifications LVD, RED, EMC, CE



[more info →](#)

## SENSORS & REMOTE CONTROL



### Shelly BLU Distance



Power supply	1x LISOC 14505 2700mAh - 3.6 V battery
Battery life	Up to 4 years
Ultrasonic sensor	200 mm - 5000 mm
Connectivity	Bluetooth 5
CPU	Silicon Labs - EFR32MG27C140F768IM32
Flash Memory	768 kB
Size (HxWxD) with casing	117.90 mm / 4.64 in x 35.30 mm / 1.39 in
Weight	105 g / 3.70 oz (Device with battery)
Certifications	LVD, RED, EMC, CE

more info →

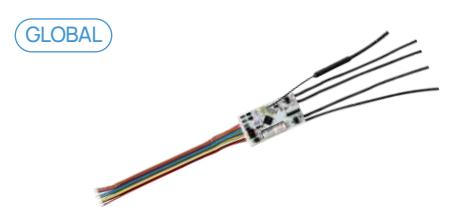


### Shelly BLU Remote Control ZB



Power supply	2x AAA - 1.5 V batteries
Battery life	Up to 2 years
Connectivity	Bluetooth 5 Zigbee 802.15.4
CPU	EFR32MG27
Flash Memory	768 kB
Size (HxWxD)	129x47x24 mm / 5.08x1.85x0.94 inch
Weight	63 g / 2.22 oz (without batteries) 85 g / 3.00 oz (with batteries)
Certifications	LVD, RED, EMC, CE, FCC

more info →



### Shelly Plus UNI



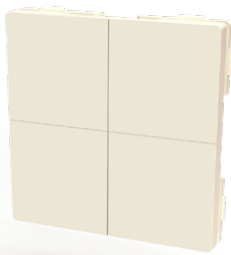
Power supply	8-24 V~ 9-28 V== 5 V== (stabilized, via +5 V== and GND)
Max. control voltage	30 V
Max. control current	300 mA
Connectivity	W-Fi 4 Bluetooth 4.2
CPU	ESP32-U4WDH
Flash Memory	4 MB
Size (HxWxD)	40x21x7 mm / 1.57x0.83x0.28 in
Certifications	LVD, RED, EMC, CE

more info →





GLOBAL



### Shelly BLU Wall Switch 4 ZB



Power supply 1xCR2032 - 3V batteries

Battery life Up to 2 years

Connectivity Bluetooth 5.0  
Zigbee 802.15.4

Size (HxWxD) 46x46x13 mm /  
1.81x1.81x0.51 in

Weight 17 g / 0.6 oz

Certifications LVD, RED, EMC, CE

### Shelly Adapters for BLU Wall Switch4

Gira, Merten



Busch-Jaeger



Shelly, Legrand



more info →





GLOBAL



Shelly  
**BLU Wall Switch 4 ZB DK**



Power supply **1xCR2032, 3 V batteries**

Battery life **Up to 2 years**

Mounting **Wall mounting**

Connectivity **Bluetooth 5.0  
Zigbee 802.15.4**

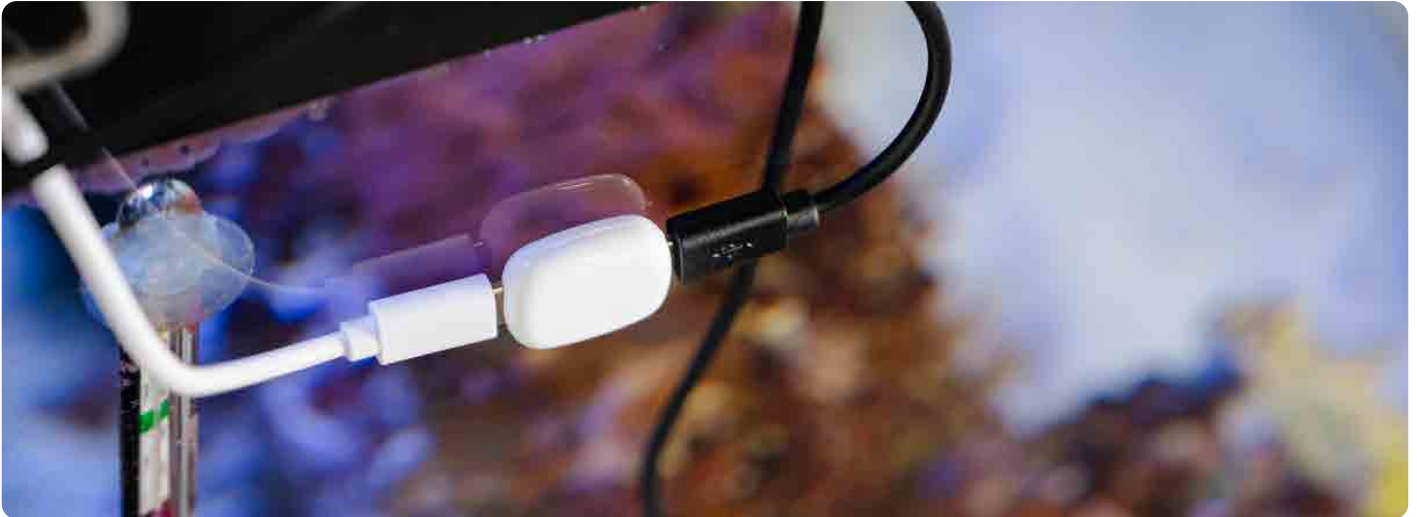
Size (HxWxD) **63x63x11 mm /  
2.48x2.48x0.43 in**

Weight **27 g / 0.96 oz**

Certifications **LVD, RED, EMC, CE**

[more info →](#)





GLOBAL



## The Pill by Shelly



Power supply USB Type-C +5V<sup>---</sup>

Power consumption < 1 W

Voltmeter (DC) 0 V - 2.5 V (Built-in)

Connectivity W-Fi 4  
Bluetooth 4.2

CPU ESP-Shelly-C38F

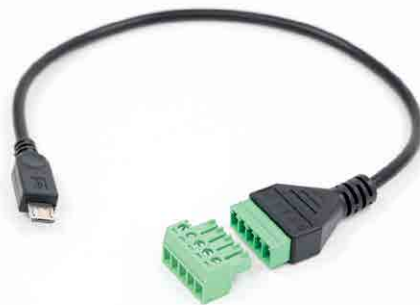
Flash Memory 8 MB

Size (HxWxD) 26 x 19.95 x 8.5 mm /  
with casing 1.02 x 0.79 x 0.34 inch

Weight 3 g / 0.11 oz

Certifications LVD, RED, EMC, CE

[more info →](#)



## 5-Terminal Add-on

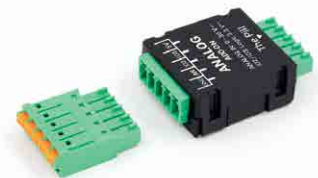
(Accessory for The Pill by Shelly)

Interface module for The Pill by Shelly providing power, ground, and three configurable I/O terminals. Perfect for connecting sensors, buttons, or other control elements in any setup.



## Temperature sensor DS18B20 - 3.5 mm jack, 1 m cable

Digital temperature sensor with 1 m cable and 3.5 mm jack, compatible with The Pill by Shelly. Designed for accurate air or liquid temperature monitoring in residential or commercial environments.



## Analog 0-30 V Add-on

(Accessory for The Pill by Shelly)

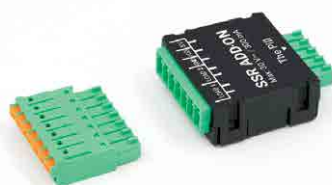
Add-on module for The Pill by Shelly that measures analog sensors and DC voltages up to 30 V. Ideal for monitoring batteries, power supplies, and other low-voltage devices.



## Splitter 1 to 5 - 3.5mm jack

(Accessory for The Pill by Shelly)

1-to-5 splitter cable that lets The Pill by Shelly connect multiple DS18B20 temperature sensors at once. Suitable for multi-point temperature tracking in smart homes or industrial systems.



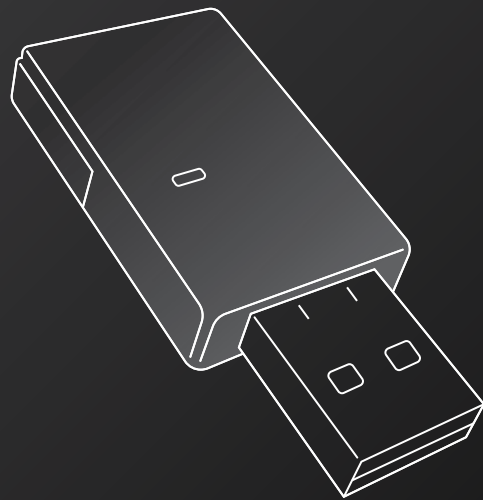
## SSR Add-on

(Accessory for The Pill by Shelly)

Dual-channel solid-state relay module for The Pill by Shelly, controlling two independent DC loads up to 30 V/300 mA. Great for safe and silent control of lights, fans, or other DC devices.



# Accessories





GLOBAL



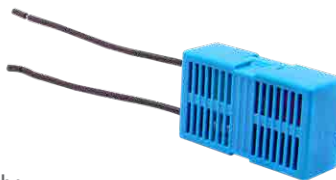
### Shelly Bypass

Working voltage **230 V~**  
 Compatible with **- Shelly 1L  
 - Shelly Dimmer 2**  
 Size (HxWxD) **39x23x13 mm /  
 1.54x0.91x0.51 inch  
 (without wires)**

[more info →](#)



GLOBAL



### Shelly Bypass for 1L/2L

Working voltage **230 V~**  
 Compatible with **- Shelly 1LGen3  
 - Shelly 2LGen3**  
 Size (HxWxD) **39x23x13 mm /  
 1.54x0.91x0.51 inch  
 (without wires)**

[more info →](#)



GLOBAL



### Shelly Bypass for Dimmer

Working voltage **230 V~**  
 Compatible with **- Shelly Dimmer Gen3**  
 Size (HxWxD) **39x23x13 mm /  
 1.54x0.91x0.51 inch  
 (without wires)**

[more info →](#)



GLOBAL



### Shelly RC Snubber

Capacitance **0.1 μF**  
 Resistance **100 Ω**  
 Rated voltage **600 V~**

[more info →](#)



GLOBAL



### Shelly BLU Gateway

Power supply **5 V==**  
 (from USB Type-A port)  
 CPU **ESP32**  
 Flash **4 MB**

[more info →](#)



GLOBAL



### Shelly BLU Gateway Gen3

Power supply **5 V==**  
 (from USB Type-A port)  
 CPU **Shelly ESP32 C3**  
 Flash **8 MB**

[more info →](#)





GLOBAL



### Shelly Plus Add-on

Add-on for Shelly Plus devices. Can be used with up to five DS18B20 sensors or one DHT22 sensor.

[more info →](#)



GLOBAL



### Shelly Temp. Sensor DS18B20

Can be used with Shelly Plus Add-on for measuring precise temperature.

Sizes:  
- 1 m  
- 3 m

GLOBAL



### Shelly LoRa Add-on

Power supply 3.3 V (from a compatible Shelly device)  
Size (HxWxD) 40x42x11 mm / 1.58x1.66x0.44 inch  
Weight 10 g / 0.4 oz  
Range Up to 5 000 m / 16 400 ft (depends on local conditions)

A compact long-range communication add-on for Shelly Gen3 and Gen4 devices\*.

#### \*Supporting devices

Shelly Gen3 Devices (1.6 firmware):

- Shelly 1 Gen3
- Shelly 1PM Gen3
- Shelly 2PM Gen3
- Shelly Shutter
- Shelly EM Gen3
- Shelly Dimmer 0/1-10V PM Gen3
- Shelly DALI Dimmer Gen3

Shelly Gen4 Devices (1.6 firmware):

- Shelly 1 Gen4
- Shelly 1PM Gen4
- Shelly 2PM Gen4

[more info →](#)



GLOBAL



### Shelly LAN Switch

Power supply 110 - 240 V~  
Size (HxWxD) 96x53x59 mm / 3.78x2.01x2.32 in  
Weight 87 g / 3 oz  
Ethernet ports 5 x RJ45 connectors  
Certifications LVD, RED, EMC

[more info →](#)





GLOBAL



Shelly  
**Shelly 50 A Current Transformer Clamp**

Working voltage **230 V~**

Compatible with  
- Shelly Pro EM-50  
- Shelly EM Gen3

GLOBAL



Shelly  
**Shelly 80 A Solid core Current Transformer**

GLOBAL



Shelly  
**Shelly 120 A Current Transformer Clamp**

GLOBAL



Shelly  
**Shelly 400 A Current Transformer Clamp**

EU  
ANZ



Shelly  
**Wall Display Stand White / Black**

A tabletop stand for Shelly Wall Display setting the display under 35° viewing angle for ease of interaction.

Power supply **230 - 240 V~ 50/60 Hz**

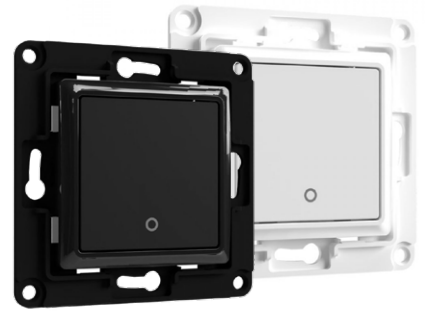
Size (HxWxD) **87x87x113 mm / 3.43x3.43x5.24 inch**

[more info →](#)



# Wall Switch for smart device

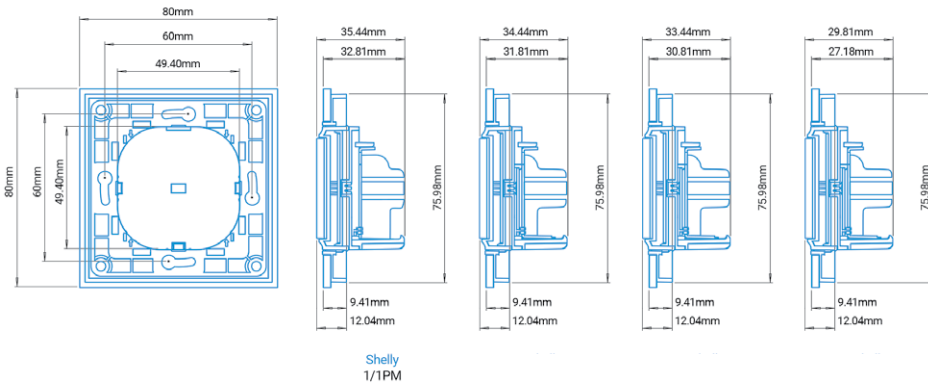
Designed to facilitate your specific automation needs and developed with the smallest details in mind, you can now create a custom wall switch for your Shelly device, and save on space and money!



GLOBAL

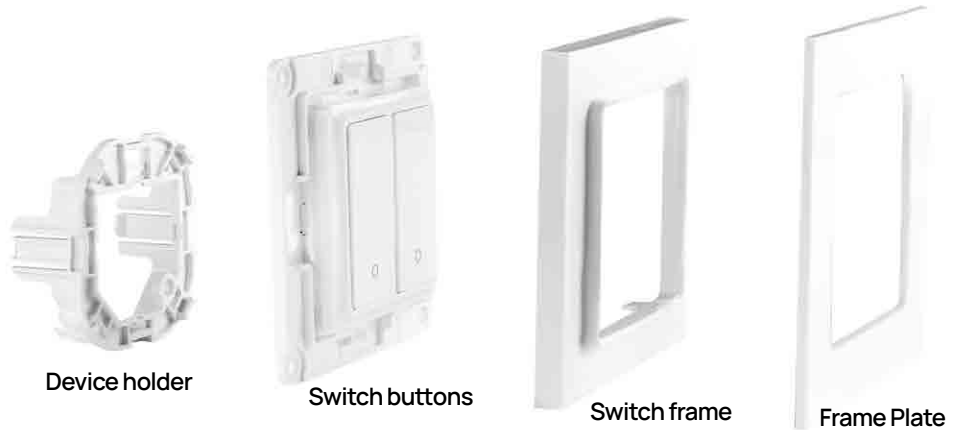
## FITS INTO THE TINIEST SPACES!

Compact dimensions and simple wiring that can fit into any existing switch console or even the tiniest spaces.

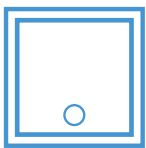


## HIGHLY CUSTOMIZABLE!

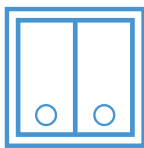
Each Shelly Wall Switch for Smart device comes with corresponding holders. You can choose the device holder that you need to fulfill your automation project.



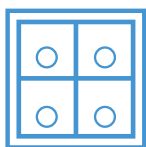
### AVAILABLE SWITCHES\*:



Shelly Plus, Gen3 and Gen4 Series\*

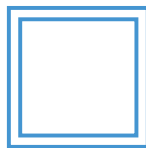


Shelly Plus, Gen3 and Gen4 Series\*

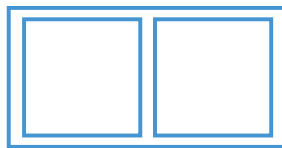


Shelly Plus, Gen3 and Gen4 Series\*

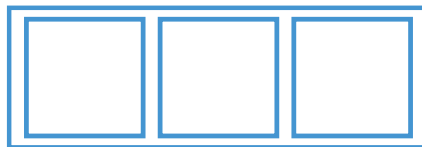
### AVAILABLE FRAMES\*:



Single frame

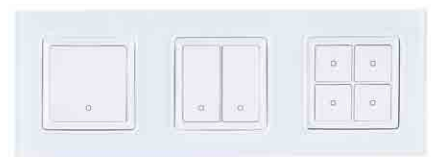


Double frame



Triple frame

### AVAILABLE COLORS:



White



Black

\*Shelly Wall switches and Shelly Wall frames are sold separately!

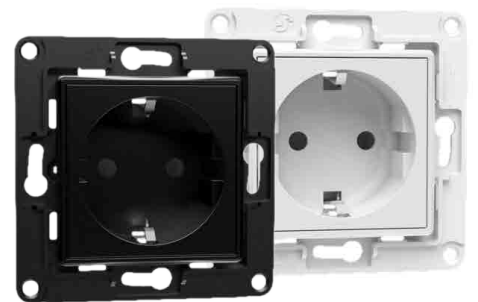


## Shelly Wall Socket EU

EU

It can fit into any existing wall socket console or even the tiniest spaces due to its compact dimensions and simple wiring. Type F/Shuko.

\* There is no relay device included in the package.



## Shelly Wall Socket UK

UK

Shelly Wall Socket can fit into any existing wall socket console or even the tiniest spaces due to its compact dimensions and simple wiring. When combined with the Shelly Wall Switch, your home acquires a beautiful, unified interior design. United Kingdom standard. Type G/BS 1363

\* There is no relay device included in the package.



## Shelly Button Add-on

EU

Lets you safely use Shelly relays and dimmers outside of wall boxes, turning almost any device into a smart one. You insert a compatible Shelly device inside the Button Add-on and use the integrated wiring to connect your appliance to the power supply and switch control.

\* There is no relay device included in the package.



*Shelly*

Explore the  
**POSSIBILITIES**