



## Neve Up: Button 1M light symbol white

**09021.L**

Neve Up / Devices / Basic devices

### Button 1M light symbol white

1-module interchangeable button, lighTable light symbol, white

### Stato prodotto

3 - Active

### Q.tà minima ordine

50 NR

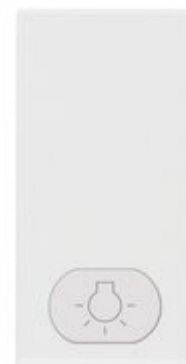

Potrebbe interessarti anche



09005.0.250 - 1P 16AX 2-  
way switch  
mechan.+pilot250V



09008.0.250 - 1P NO 10A  
push button mechan.+pilot  
250V



09008.0.12 - 1P NO 10A  
push button mechan.+pilot  
12V

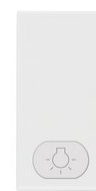

09021.L - Button 1M light  
symbol white

Dis

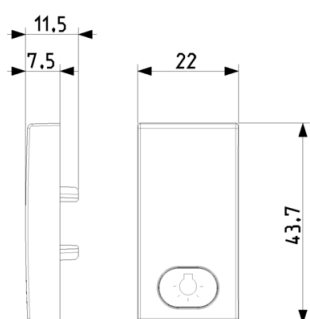

Vista ingombri

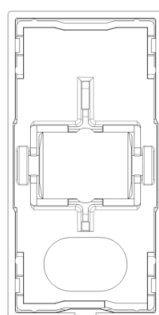

Vista posteriore

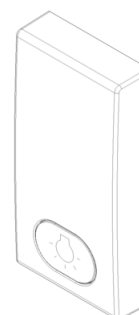

Vista 3D



## Dati tecnici

- **Class group:** Domestic switching devices
- **Class:** Control element/cover plate for domestic switching devices
- **Model:** Single rocker
- **Utilization:** Switch/push button
- **Suitable for touch sensor connector for bus system:** No
- **Type of fastening:** Clamp mounting
- **Monitoring window/light outlet:** Yes
- **Material:** Plastic
- **Material quality:** Thermoplastic
- **Surface protection:** Untreated
- **Surface finishing:** Glossy
- **Colour:** White
- **RAL-number (similar):** 9016
- **With exchangeable lens/symbol:** Yes
- **Depth:** 750 mm

## Marchi

- 00. CE Marking - EU
- 29. QCERT - Colombia ([download](#))

## Imballi



8 007352 659292  
**Codice** 8007352659292  
**Qtà** 1 NR  
**Dim.** 2.2x4.4x1.1 [cm]  
**Peso** 4 [g]



8 007352 659308  
**Codice** 8007352659308  
**Qtà** 5 NR  
**Dim.** 5.1x2.8x5.3 [cm]  
**Peso** 24.2 [g]



8 007352 659315  
**Codice** 8007352659315  
**Qtà** 50 NR  
**Dim.** 14.4x11.6x6 [cm]  
**Peso** 283.6 [g]



8 007352 668621  
**Codice** 8007352668621  
**Qtà** 600 NR  
**Dim.** 36.5x33x13.5 [cm]  
**Peso** 3,206 [g]

## Legal

Vimar si riserva il diritto di modificare in ogni momento e senza preavviso le caratteristiche dei prodotti riportati. L'installazione deve essere effettuata da personale qualificato con l'osservanza delle disposizioni regolanti l'installazione del materiale elettrico in vigore nel paese dove i prodotti sono installati. Per le condizioni di utilizzo delle informazioni presenti sulla scheda prodotto vedere [Conditions of Use](#).