



Neve Up: Button 1M key symbol white

09021.P

Neve Up / Devices / Basic devices

Button 1M key symbol white

1-module interchangeable button, lighTable key symbol, white

Stato prodotto

3 - Active

Q.tà minima ordine

50 NR

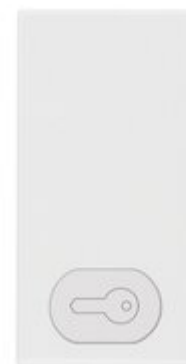

Potrebbe interessarti anche



09005.0.250 - 1P 16AX 2-
way switch
mechan.+pilot250V



09008.0.250 - 1P NO 10A
push button mechan.+pilot
250V



09008.0.12 - 1P NO 10A
push button mechan.+pilot
12V



09021.P - Button 1M key
symbol white

Dis

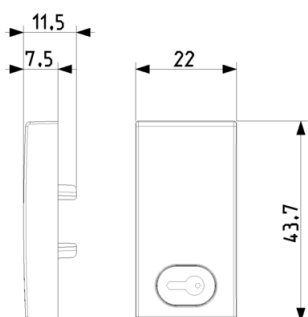

Vista ingombri

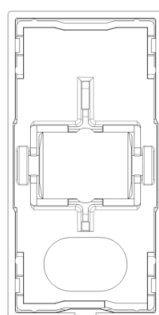

Vista posteriore

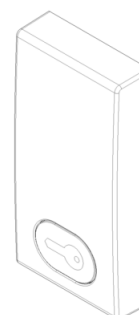

Vista 3D





Dati tecnici

- **Class group:** Domestic switching devices
- **Class:** Control element/cover plate for domestic switching devices
- **Model:** Single rocker
- **Utilization:** Switch/push button
- **Suitable for touch sensor connector for bus system:** No
- **Type of fastening:** Clamp mounting
- **Monitoring window/light outlet:** Yes
- **Material:** Plastic
- **Material quality:** Thermoplastic
- **Surface protection:** Untreated
- **Surface finishing:** Glossy
- **Colour:** White
- **RAL-number (similar):** 9016
- **With exchangeable lens/symbol:** Yes
- **Depth:** 750 mm

Marchi

- 00. CE Marking - EU
- 29. QCERT - Colombia ([download](#))

Imballi

8 007352 659520
Codice 8007352659520
Qtà 1 NR
Dim. 2.2x4.4x1.1 [cm]
Peso 3.2 [g]
8 007352 659537
Codice 8007352659537
Qtà 5 NR
Dim. 5.1x2.8x5.3 [cm]
Peso 19 [g]
8 007352 659544
Codice 8007352659544
Qtà 50 NR
Dim. 14.4x11.6x6 [cm]
Peso 223.73 [g]
8 007352 668669
Codice 8007352668669
Qtà 600 NR
Dim. 36.5x33x13.5 [cm]
Peso 2,682 [g]

Legal

Vimar si riserva il diritto di modificare in ogni momento e senza preavviso le caratteristiche dei prodotti riportati. L'installazione deve essere effettuata da personale qualificato con l'osservanza delle disposizioni regolanti l'installazione del materiale elettrico in vigore nel paese dove i prodotti sono installati. Per le condizioni di utilizzo delle informazioni presenti sulla scheda prodotto vedere [Conditions of Use](#).