

Data sheet | Item number: 773-106

PUSH WIRE® connector for junction boxes; for solid and stranded conductors; max. 2.5 mm²; 6-conductor; transparent housing; violet cover; Surrounding air temperature: max 60°C; 2,50 mm²; multicoloured

www.wago.com/773-106

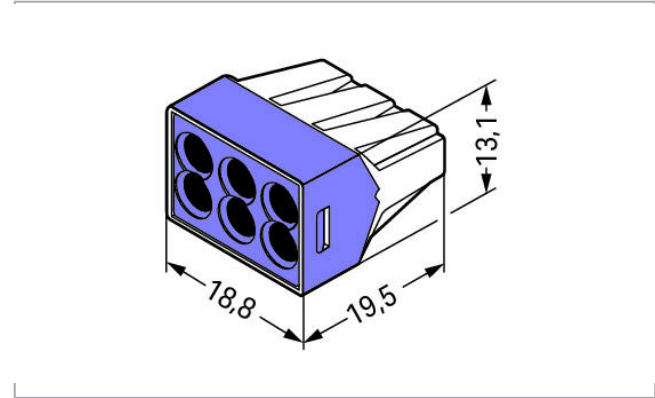

RoHS 
Compliant

[BOMcheck.net](https://www.bomcheck.net)

Item description

Note:

Terminating Aluminum Conductors

WAGO spring clamp terminal blocks are suitable for solid aluminum conductors up to 4 mm²/12 AWG if WAGO "Alu-Plus" Contact Paste is used for termination.

"Alu-Plus" Contact Paste Advantages:

- Automatically destroys the oxide film during clamping.
- Prevents fresh oxidation at the clamping point.
- Prevents electrolytic corrosion between aluminum and copper conductors (in the same terminal block).
- Provides long-term protection against corrosion.

For spring clamp connections with PUSH WIRE® connection technology, **WAGO recommends that the aluminum conductor first be cleaned** and then immediately inserted into the clamping unit filled with "Alu-Plus" contact paste.

It is also possible to apply WAGO "Alu-Plus" **additionally** on the whole surface of the aluminum conductor before termination.

Please note that the nominal currents must be adapted to the reduced conductivity of the aluminum conductors::

2.5 mm² = 16 A

Subject to changes. Please also observe the further product documentation!

WAGO Kontakttechnik GmbH & Co. KG
Hansastr. 27
32423 Minden
Phone: +49571 887-0 | Fax: +49571 887-169
Email: info.de@wago.com | Web: www.wago.com

Do you have any questions about our products?
We are always happy to take your call at +49 (571) 887-44222.



4 mm² = 22 A

Safety information 1:

in grounded power lines

Safety information 2:

When using conductors of exclusively the same cross-section, 0.75 mm²/18 AWG is also possible.

Data

Electrical data

Ratings per IEC/EN 60664-1

Ratings per	IEC/EN 60664-1
Nominal voltage (II/2)	400 V
Rated surge voltage (II/2)	4 kV
Rated current	24 A
Legend (ratings)	(II / 2) ≙ Overvoltage category II / Pollution degree 2

Connection data

Connection technology	PUSH WIRE [®]
Actuation type	Push-in
Connectable conductor materials	Copper Aluminum
Solid conductor	0.75 ... 2.5 mm ² / 18 ... 12 AWG
Stranded conductor	1.5 ... 2.5 mm ² / 16 ... 12 AWG
Strip length	12 mm / 0.47 inch
Total number of connection points	6
Total number of potentials	1
Wiring type	Side-entry wiring

Physical data

Width	18.8 mm / 0.74 inch
Height	13.1 mm / 0.516 inch
Depth	19.5 mm / 0.768 inch

Material Data

Color	multicoloured
Cover color	violet
Flammability class per UL94	V2

Subject to changes. Please also observe the further product documentation!

Weight	3.5 g
--------	-------

Environmental Requirements





Surrounding air temperature (operation)	60 ... 60 °C
---	--------------

Commercial data

Product Group	7 (Push Wire Conn.)
Packaging type	BOX
Country of origin	CN
GTIN	4044918397681
Customs tariff number	85369010000

Approvals / Certificates

Country specific Approvals

Logo	Approval	Additional Approval Text	Certificate name
	CCA UL International Demko A/S	EN 60998	CCA-DK No. 2520
	CSA DEKRA Certification B.V.	C22.2	15411 (LR46759)
	KEMA/KEUR DEKRA Certification B.V.	EN 60998	71- 101747
	ÖVE Österreichischer Verband für Elektrotechnik	EN 60998	1193-031- 09

Ship Approvals

Logo	Approval	Additional Approval Text	Certificate name
	ABS American Bureau of Shipping	-	18- HG1755093- PDA
	BV	EN 60998	11914/DO

Subject to changes. Please also observe the further product documentation!



Bureau Veritas S.A.

BV

**DNV GL**

Det Norske Veritas, Germanischer Lloyd

EN 60998



TAE000015T

**LR**

Lloyds Register

EN 60998

04/20013
(E8)**UL-Approvals**

Logo	Approval	Additional Approval Text	Certificate name
	UL UL International Germany GmbH	EN 60998	D-03479-A1
	UL UL International Germany GmbH	UL 486C	E69654

Counterpart**Compatible products****General accessories****Item no.: 249-130**

Syringe; Contents: 20 ml Alu-Plus contact paste

www.wago.com/249-130**Mounting adapter****Item no.: 773-332**Mounting carrier; 773 Series - 2.5 mm² / 4 mm² / 6 mm²; for DIN-35 rail mounting/screw mounting; orangewww.wago.com/773-332**Downloads****Documentation****Additional Information**

Subject to changes. Please also observe the further product documentation!

WAGO Kontakttechnik GmbH & Co. KG

Hansastr. 27

32423 Minden

Phone: +49571 887-0 | Fax: +49571 887-169

Email: info.de@wago.com | Web: www.wago.com

Do you have any questions about our products?

We are always happy to take your call at +49 (571) 887-44222.



Technical explanations

Apr 3, 2019

pdf
2.2 MB

Download

CAD/CAE-Data

CAE data

WSCAD Universe 773-106

URL

Download

Installation Notes

Subject to changes. Please also observe the further product documentation!

WAGO Kontakttechnik GmbH & Co. KG
Hansastr. 27
32423 Minden
Phone: +49571 887-0 | Fax: +49571 887-169
Email: info.de@wago.com | Web: www.wago.com

Do you have any questions about our products?
We are always happy to take your call at +49 (571) 887-44222.