



Module Clio G2

- Fits well in slim ceiling luminaires
- Easy and flexible installation
- Shadow free, homogeneous light diffusion
- Integrated driver
- Including magnets and connection box
- Daylight and motion sensor accessory available

Specifications

Item Code	Item Description	Equivalent to (W)	Power (W)	Lumen	Efficacy (lm/W)	CCT (K)	Weight (kg/pc)
Dimmable (Triac)							
140066207	LED E C module 36W DIM 4000K Clio CT	CFL TC-DD/PL-Q 38W	36	3900	109	4000	0.49

Packaging Information

Item			Box			
Item Code	Item Description	EU HS Code	Dimensions (mm) (LxWxH)	Gross Weight (kg)	EAN	pc/box
140066207	LED E C module 36W DIM 4000K Clio CT	94054239	324x35x324	0.67	6945730472342	1
821017001200	LEDsmart-BLE-Relay-250W-DIM	94059200	90x40x30	0.08	6941408898469	1
821017003600	LEDsmart-BLE2-Relay-250W-DIM	94059200	90x40x30	0.09	6931783007594	1

Technical Specifications	
Lifetime (L70)	30,000 h
Lifetime (L80)	20,000 h
On-/Off-cycles	100,000
Dimmability	Triac
Beam angle	150°
Colour rendering index (CRI)	≥ 80
Degree of protection (IP)	IP20
Protection class	II
With control gear	Yes

Electrical Supply	
Frequency	50/60 Hz
Nominal voltage	220-240 V
DC input voltage	No
230V Cable length	0.3 m

Ambient Conditions	
Operating temperature	-20-+40°C
Application temperature	+25°C
Storage environment	-25-+50°C

3 YEARS WARRANTY



ENERGY

OPPLE Lighting
140066207

36
kWh/1000h

2019/2015

Dimensional Drawing (mm)

LED E C module 36W

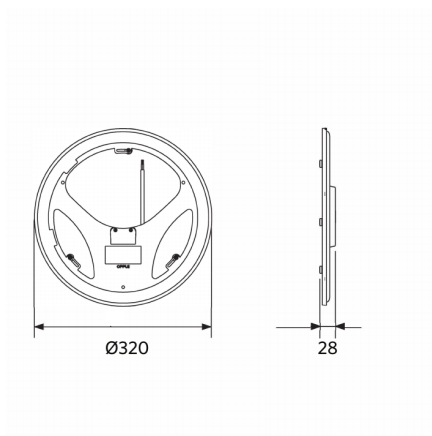

LED E C module
Module sensor CT

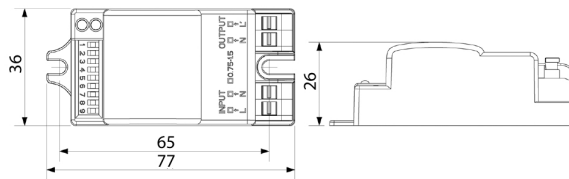

Photometric Data

