



- Professional post-top solution with optimal light performance
- Integrates well into existing landscape
- Different optics to suit the application and reduce glare
- Die casted aluminium body for optimal heat dissipation
- IP66 and suitable for use on coastal applications



Specifications

Item Code	Item Description	Equivalent to (W)	Power (W)	Lumen	Efficacy (lm/W)	CCT (K)	Beam angle	Compatible pole Ø (mm)	Weight (kg/pc)
On-Off									
708000000200	LEDPostTop-P 50W-3000-AS-D76	HID 70W	50	6000	120	3000	40° x 150°	76 mm	7.72

Accessories



599000004600
LEDStreet-SE-ExtensionCable-6m

Packaging Information

Item			Box			
Item Code	Item Description	EU HS Code	Dimensions (mm) (LxWxH)	Gross Weight (kg)	EAN	pc/box
708000000200	LEDPostTop-P 50W-3000-AS-D76	94054239	530x530x285	9.44	6941408856902	1
599000004600	LEDStreet-SE-ExtensionCable-6m	85444290	100x60x350	0.68	6956321815370	1

Technical Specifications	
Lifetime (L70)	100,000 h
Lifetime (L80)	70,000 h
On-/Off-cycles	100,000
Colour consistency (SDCM)	5
Dimmability	On-Off
Finishing	Grey RAL 870-3
Colour rendering index (CRI)	≥ 70
Degree of protection (IP)	IP66
Impact strength	IK08
Protection class	I
Risk group (EN 62471)	RG0
With control gear	Yes
Glow wire test	850°C
Power factor	≥ 0.9
Surge protection	10 kV

Electrical Supply	
Frequency	50/60 Hz
Nominal voltage	220-240 V
DC input voltage	See catalogue appendix Connection Specifications

Mechanical Properties	
Housing material	Aluminium
Optical material	Polycarbonate
Cover material	Tempered glass
Effective wind area	1590 cm ²
Coastal proof	Yes

Ambient Conditions	
Operating temperature	-30-+50°C
Application temperature	+25°C
Storage environment	-40-+60°C



OPPLE Lighting
70800000200

A	▶
B	▶
C	▶
D	▶
E	▶
F	▶
G	▶

E

50
kWh/1000h

2019/2015

Dimensional Drawing (mm)

LEDPostTop-P
D60

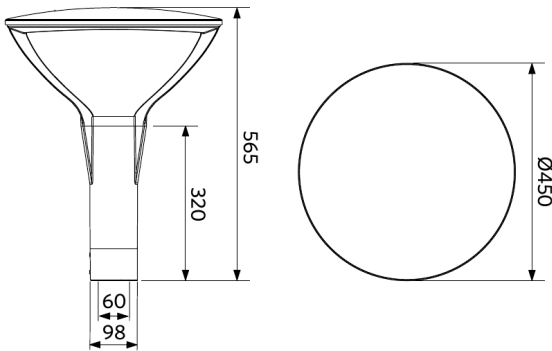

LEDPostTop-P
D76

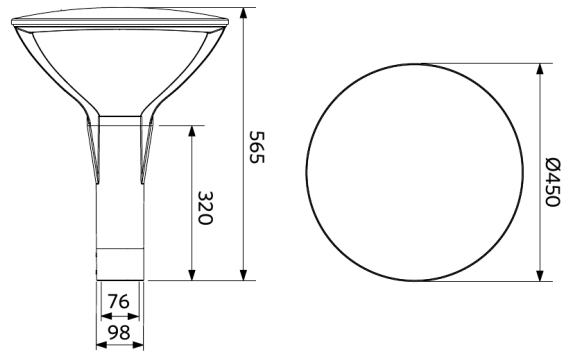

Photometric Data

