



## Ceiling Light Apollo G4

- Elegant wall/ceiling luminaire with improved design
- Flexible due to CCT switch and Power switch
- IP44 waterproof, also suitable for bathrooms and comparable spaces
- Bracket accessory available for easy mounting on existing installations (no new screw holes needed)
- 3 different sizes: 250/350/450mm



## Specifications

Item Code	Item Description	Equivalent to (W)	Power (W)	Lumen	Efficacy (lm/W)	CCT (K)	Ingress Protection (IP)	Weight (pc/kg)
Dimmable (Triac)/Motion Detection/Daylight Detection								
520033017600	LEDApollo-E4 Rd250-6/12W-DIM-827/840-MD	GLS 75W	12	1200	100	2.7K/4K	IP44	0.4

## Accessories



520098000200  
LED Apollo HC300 bracket

## Packaging information

Item			Box			
Item Code	Item Description	EU HS Code	Dimensions (mm) (LxWxH)	Gross Weight (kg)	EAN	pc/box
520033017600	LEDApollo-E4 Rd250-6/12W-DIM-827/840-MD	94051190	270x270x74	1.56	6931783046708	1
520098000200	LED Apollo HC300 bracket	94059900	234x86x49	0.16	6956321815387	1

Technical Specifications	
Lifetime (L70)	50,000 h
Lifetime (L80)	30,000 h
On-/Off-cycles	100,000
Dimmability	Triac
Sensor type	Motion + Daylight detection (MD)
Sensor technology	Microwave (MW)
CCT (K)	2,700 - 4,000 K
Beam angle	120 °
Finishing	White RAL9003
RAL-Number	9003
Colour rendering index (CRI)	> 80
Impact strength (IK)	IK02
Protection class	II
Risk group (EN 62471)	RG0
With control gear	True
Power factor	≥ 0.85

Electrical Supply	
Frequency	50 - 60 Hz
Nominal voltage	220 - 240 V
DC input voltage	See catalogue appendix Connection Specifications

Mechanical Properties	
Housing material	Plastic
Optical material	Polycarbonate

Ambient Conditions	
Operating temperature	-10 ~ 45 °C
Application temperature	25 °C
Storage environment	-25 - 50 °C

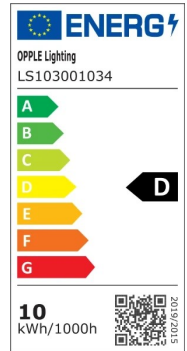

## Dimensional Drawing (mm)

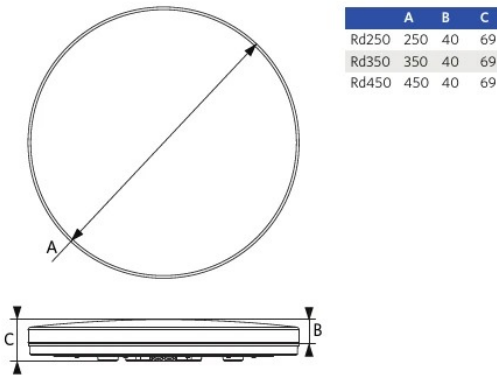

## Motion Sensors

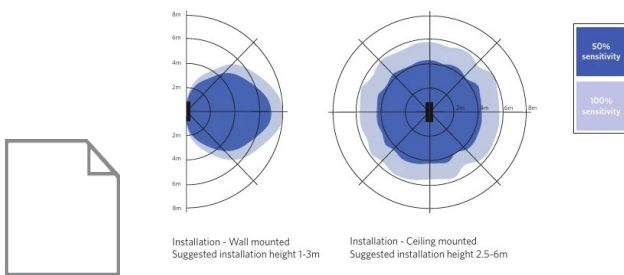

# Photometric Data

