

Spot Performer 3C Compact G2

- High performance compact track spot with high luminous efficacy and homogeneous light distribution
- Integrated in-track driver with a 4-step DIP switch for simple power selection
- Fitting common Global/Nordic Aluminum® 3C Tracks - and many other standard types



Specifications

Item Code	Item Description	Equivalent to (W)	Power (W)	Lumen (lm)	Efficacy (lm/W)	CCT (K)	RAL-Number	Net Weight (kg/pc)
568001032100	LEDspot3C-C-P2 30W-930-36D-BL	HID 50W	30	4050	135	3000	9004	0.599

Packaging information

Item			Box			
Item Code	Item Description	EU HS Code	Dimensions (mm) (LxWxH)	Gross Weight (kg/pc)	EAN	pc/box
568001032100	LEDspot3C-C-P2 30W-930-36D-BL	94051190	163x84x212	0.67	6937209609434	1

Technical Specifications

Lifetime (L70)	70,000 h
Lifetime (L80)	50,000 h
On-/Off-cycles	100,000
Colour consistency (SDCM)	4
Dimmability	On-Off
Beam angle	36 °
Maximum tilt angle	85 °
Finishing	Matte Black
Colour rendering index (CRI)	> 90
Impact strength (IK)	IK03
Protection class	II
Risk group (EN 62471)	RG1
With control gear	True
Glow wire test	650 °C
Driver failure rate (at 5,000 hrs)	≤ 1 %
Power factor	≥ 0.9

Electrical Supply

Frequency	50 - 60 Hz
Nominal voltage	220 - 240 V
DC input voltage	See catalogue appendix Connection Specifications

Mechanical Properties

Housing material	Aluminium
Optical material	Polycarbonate
Lens material	Polycarbonate

Ambient Conditions

Operating temperature	-10 - 35 °C
Application temperature	25 °C
Storage environment	-25 - 50 °C

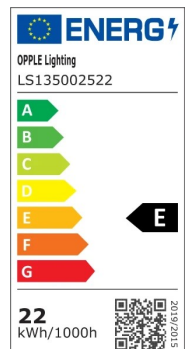

Dimensional Drawing (mm)

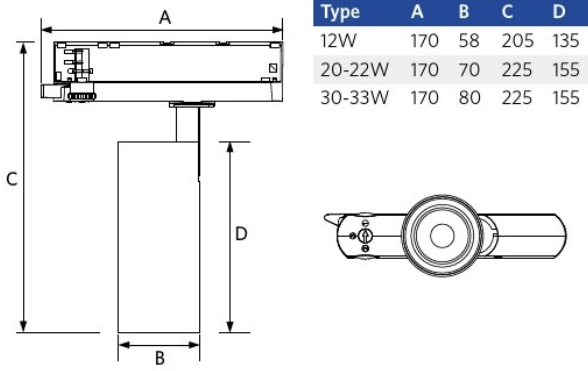

Photometric Data

